

# Dell UltraSharp 38 Curved USB-C Hub Monitor - U3824DW

## User's Guide

**Model: U3824DW**  
**Regulatory model: U3824DWb**



 **NOTE:** A NOTE indicates important information that helps you make better use of your computer.

 **CAUTION:** A CAUTION indicates potential damage to hardware or loss of data if instructions are not followed.

 **WARNING:** A WARNING indicates a potential for property damage, personal injury, or death.

**Copyright © 2023 Dell Inc. or its subsidiaries. All rights reserved.** Dell, EMC, and other trademarks are trademarks of Dell Inc. or its subsidiaries. Other trademarks may be trademarks of their respective owners.

2023 - 06

Rev. A00

# Contents

<b>Safety instructions</b> . . . . .	<b>6</b>
<b>About your monitor</b> . . . . .	<b>7</b>
Package contents . . . . .	7
Product features . . . . .	9
<b>Identifying parts and controls</b> . . . . .	<b>10</b>
Front view . . . . .	10
Back view . . . . .	11
Bottom view . . . . .	12
<b>Monitor specifications</b> . . . . .	<b>15</b>
Resolution specifications . . . . .	17
Supported video modes . . . . .	17
Preset display modes . . . . .	18
Electrical specifications . . . . .	19
Physical characteristics . . . . .	20
Environmental characteristics . . . . .	21
<b>Pin assignments</b> . . . . .	<b>22</b>
DisplayPort connector . . . . .	22
HDMI connector . . . . .	23
Universal Serial Bus (USB) interface . . . . .	24
RJ45 connector . . . . .	27
<b>Plug and play capability</b> . . . . .	<b>31</b>
<b>LCD monitor quality and pixel policy</b> . . . . .	<b>31</b>
<b>Ergonomics</b> . . . . .	<b>32</b>
<b>Handling and moving your display</b> . . . . .	<b>34</b>
<b>Maintenance guidelines</b> . . . . .	<b>35</b>
Cleaning your monitor . . . . .	35



- Setting up the monitor . . . . . 37**
  - Attaching the stand . . . . . 37
  - Connecting your monitor . . . . . 40
    - Connecting the DisplayPort (DisplayPort to DisplayPort) cable . . 41
    - Connecting the HDMI cable . . . . . 41
    - Connecting the USB Type-C cable (USB-C to USB-C) . . . . . 41
    - Connecting the USB Type-C cable (USB-C to USB-A) . . . . . 42
    - Connecting the super speed USB 10 Gbps (USB 3.2 Gen2) cable . . . . . 42
    - Connecting the monitor for RJ45 cable (optional) . . . . . 43
  - Dell Power Button Sync (DPBS) . . . . . 44
    - Connecting the monitor for DPBS for the first time . . . . . 47
    - Using DPBS function . . . . . 48
    - Connecting the monitor for USB-C . . . . . 50
  - Organizing your cables . . . . . 52
  - Securing your monitor using Kensington lock (optional) . . . . . 52
  - Removing the monitor stand . . . . . 53
  - VESA wall mounting (optional) . . . . . 54
- Operating the monitor . . . . . 55**
  - Power on the monitor . . . . . 55
  - Using the joystick control . . . . . 55
  - Using the On-Screen Display (OSD) menu . . . . . 56
    - Accessing the Menu Launcher . . . . . 56
    - Using the navigation keys . . . . . 57
    - Accessing the menu system . . . . . 58
    - OSD warning message . . . . . 76
  - Locking the control buttons . . . . . 82
  - Setting the KVM switch . . . . . 83
  - Setting the maximum resolution . . . . . 85





<b>Using the tilt, swivel, vertical extension, and slant adjust . . . . .</b>	<b>86</b>
<b>Tilt, swivel . . . . .</b>	<b>86</b>
<b>Vertical extension . . . . .</b>	<b>86</b>
<b>Slant adjust . . . . .</b>	<b>87</b>
<b>Troubleshooting . . . . .</b>	<b>88</b>
<b>Self-test . . . . .</b>	<b>88</b>
<b>Common problems . . . . .</b>	<b>89</b>
<b>Product specific problems . . . . .</b>	<b>93</b>
<b>Universal Serial Bus (USB) specific problems . . . . .</b>	<b>94</b>
<b>Speakers specific problems . . . . .</b>	<b>95</b>
<b>Regulatory information . . . . .</b>	<b>96</b>
<b>FCC notices (U.S. only) and other regulatory information . . . . .</b>	<b>96</b>
<b>EU product database for energy label and product information sheet . . . . .</b>	<b>96</b>
<b>Contacting Dell . . . . .</b>	<b>96</b>



# Safety instructions

Use the following safety guidelines to protect your monitor from potential damage and to ensure your personal safety. Unless otherwise noted, each procedure included in this document assumes that you have read the safety information that shipped with your monitor.

 **NOTE: Before using the monitor, read the safety information that is shipped with your monitor and printed on the product. Keep the documentation at a secure location for future reference.**

 **WARNING: Use of controls, adjustments, or procedures other than those specified in this documentation may result in exposure to shock, electrical hazards, and/or mechanical hazards.**

 **WARNING: The possible long-term effect of listening to audio at high volume through the headphones (on monitor that support it) may cause damage to your hearing ability.**

- Place the monitor on a solid surface and handle it carefully. The screen is fragile and can be damaged if dropped or hit with a sharp object.
- Ensure that your monitor is electrically rated to operate with the AC power available in your location.
- Keep the monitor in room temperature. Excessive cold or hot conditions can have an adverse effect on the liquid crystals of the display.
- Connect the power cable from the monitor to a wall outlet that is near and accessible. See [Connecting your monitor](#).
- Do not place and use the monitor on a wet surface or near water.
- Do not subject the monitor to severe vibration or high impact conditions. For example, do not place the monitor inside a car trunk.
- Unplug the monitor when it is going to be left unused for an extended period.
- To avoid electric shock, do not attempt to remove any cover or touch the inside of the monitor.
- Read these instructions carefully. Keep this document for future reference. Follow all warnings and instructions marked on the product.
- Certain monitors can be wall mounted using the VESA mount that is sold separately. Ensure to use the correct VESA specifications as mentioned in the wall mounting section of the *User's Guide*.

For information on safety instructions, see the *Safety, Environmental, and Regulatory Information (SERI)* document that is shipped with your monitor.







# About your monitor





## Package contents

The following table provides the list of components that are shipped with your monitor. If any component is missing, contact Dell. For more information, see [Contacting Dell](#).

 **NOTE: Some items may be optional and may not ship with your monitor. Some features may not be available in certain countries.**

Component image	Component description
	Display
	Stand riser
	Stand base
	Power cable (varies by country)



	<p>DisplayPort cable (DisplayPort to DisplayPort) (cable length: 1.80 M)</p>
	<p>HDMI cable (cable length: 1.80 M)</p>
	<p>USB Type-C cable (cable length: 1.00 M)</p>
	<p>USB-A to USB-C Gen2 cable (cable length: 1.00 M)</p>
	<ul style="list-style-type: none"> <li>• Quick Setup Guide</li> <li>• Safety, Environmental, and Regulatory Information</li> <li>• Factory calibration report</li> </ul>





## Product features

The **Dell U3824DW** monitor has an active matrix, Thin-Film Transistor (TFT), Liquid Crystal Display (LCD) and LED backlight. The monitor features include:

- 95.29 cm (37.52 in.) viewable area (measured diagonally).  
3840 x 1600 (21:9) resolution, plus full-screen support for lower resolutions.
- Wide viewing angle to allow viewing from a sitting or standing position.
- Color gamut of DCI-P3 98%, Display P3 98%, sRGB 100%, and Rec 709 100% with an average Delta E < 2.
- Digital connectivity with DisplayPort, USB Type-C and HDMI (supports up to WQHD+ 3840 x 1600 60 Hz TMDS as per specified in HDMI 2.1).
- Single USB Type-C to supply power (PD 90 W) to a compatible notebook while receiving video & data signal.
- Tilt, swivel, height, and slant adjustment capabilities.
- Ultra-thin bezel minimizes the bezel gap in multi-monitor usage, enabling easier setup with an elegant viewing experience.
- Removable stand and Video Electronics Standards Association (VESA™) 100 mm mounting holes for flexible mounting solutions.
- Equipped with 1 USB Type-C upstream port (video and data; DP1.4 with Alternate mode, PD up to 90 W), 1 USB Type-C upstream port (data only), 2 super speed USB 10 Gbps (USB 3.2 Gen2) Type-C downstream ports, 1 super speed USB 10 Gbps (USB 3.2 Gen2) Type-A downstream charging port, and 4 super speed USB 10 Gbps (USB 3.2 Gen2) Type-A downstream ports.
- USB-C and RJ45 ports enable a single-cable, network-connected experience.
- Plug and play capability if supported by your system.
- On-Screen Display (OSD) adjustments for ease of set-up and screen optimization.
- Supports Picture by Picture (PBP) and Picture in Picture (PIP) Select mode.
- The built-in KVM switch allows you to control up to 2 computers from a single set of keyboard and mouse connected to the monitor.
- Supports Auto KVM for multiple input setup.
- Power and joystick buttons lock.
- Security-lock slot.
- Stand lock.
- ≤ 0.5 W in Standby Mode.
- Built-in speakers (9 W) x 2.



- Optimize eye comfort with a flicker-free screen and ComfortView Plus feature.
- This monitor uses low blue light panel. When the monitor is reset to factory settings or default setting (**Preset mode: Standard**), it works in compliance with TÜV Rheinland (hardware solutions provider).

**⚠ WARNING: The possible long-term effects of blue light emission from the monitor may cause damage to the eyes, which includes but is not limited to eye fatigue and digital eye strain. ComfortView Plus feature is designed to reduce the amount of blue light emitted from the monitor to optimize eye comfort.**

## Identifying parts and controls

### Front view



Label	Description	Use
1	Power LED indicator	Solid white light indicates that the monitor is turned on and functioning normally. Blinking white light indicates that the monitor is in Standby Mode.



## Back view



## Back view with monitor stand

Label	Description	Use
1	VESA mounting holes (100 mm x 100 mm - behind attached VESA Cover)	Wall mount monitor using VESA-compatible wall mount kit (100 mm x 100 mm).
2	Regulatory label	Lists the regulatory approvals.
3	Stand release button	Releases stand from the monitor.
4	Barcode, serial number, and Service Tag label	Refer to this label if you need to contact Dell for technical support.
5	Power On/Off button	To turn the monitor on or off.
6	Joystick	Use to control the OSD menu. (For more Information, see <a href="#">Operating the monitor</a> )
7	Cable-management slot	Use to organize cables by inserting them through the slot.



## Bottom view

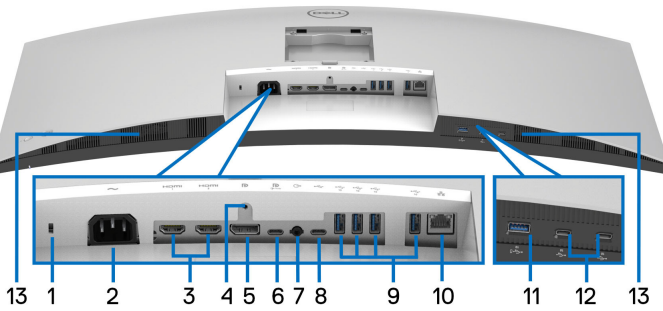

**Bottom view without monitor stand**

Label	Description	Use
1	Security-lock slot (based on Kensington Security Slot™)	Secures the monitor with a security lock (security lock not included).
2	Power connector	Connect the power cable (shipped with your monitor).
3	HDMI port (2)	Connect your computer with the HDMI cable (shipped with your monitor).
4	Stand-lock feature	To lock the stand to the monitor using a M3 x 6 mm screw (screw not included).
5	DisplayPort	Connect your computer with the DisplayPort cable (shipped with your monitor).



<p><b>6</b></p>	<p>Super speed USB 10 Gbps (USB 3.2 Gen2) Type-C upstream port (video and data)</p>	<p>Connect the USB Type-C cable that came with your monitor to the computer or mobile device. This port supports USB Power Delivery, Data, and DisplayPort video signal.</p> <p>The super speed USB 10 Gbps (USB 3.2 Gen2) Type-C port offers the fastest transfer rate and supports Alternate Mode DP1.4 with a maximum resolution of 3840 x 1600 at 60 Hz, PD 20 V/4.5 A, 15 V/3 A, 9 V/3 A, and 5 V/3 A.</p> <p><b>NOTE:</b> USB Type-C is not supported on versions of Windows prior to Windows 10 and Windows 11.</p>
<p><b>7</b></p>	<p>Audio line-out port</p>	<p>Connect your external speakers.*</p>
<p><b>8</b></p>	<p>Super speed USB 10 Gbps (USB 3.2 Gen2) Type-C upstream port (data only)</p> 	<p>Connect the USB-A to USB-C cable that came with your monitor to the computer. This port supports USB data transfer at 10 Gbps (USB 3.2 Gen2). Once this cable is connected, you can use the USB connectors on the monitor.</p> <p><b>NOTE:</b> USB Type-C is not supported on versions of Windows prior to Windows 10 and Windows 11.</p>
<p><b>9</b></p>	<p>Super speed USB 10 Gbps (USB 3.2 Gen2) Type-A downstream port (4)</p>	<p>Connect your USB device.**</p> <p><b>NOTE:</b> To use this port, you must connect the USB Type-C cable or USB Type-C to Type-A cable (shipped with your monitor) to the USB Type-C upstream port on the monitor and to your computer.</p>
<p><b>10</b></p>	<p>RJ45 port</p>	<p>Supports Ethernet connection 10/100/1000/2500 Mbps.</p> <p>Connect the Internet. You can surf the Internet via RJ45 only after you have connected the USB Type-C cable or USB Type-C to Type-A cable (shipped with your monitor) to the USB Type-C upstream port on the monitor and to your computer.</p>



<b>11</b>	Super speed USB 10 Gbps (USB 3.2 Gen2) Type-A downstream port with Power Charging	Connect your USB device** or charge your device. <b>NOTE:</b> To use this port, you must connect the USB Type-C cable or USB Type-C to Type-A cable (shipped with your monitor) to the USB Type-C upstream port on the monitor and to your computer.
<b>12</b>	Super speed USB 10 Gbps (USB 3.2 Gen2) Type-C downstream port (2)	Connect your USB device.** <b>NOTE:</b> To use this port, you must connect the USB Type-C cable or USB Type-C to Type-A cable (shipped with your monitor) to the USB Type-C upstream port on the monitor and to your computer.
<b>13</b>	Speakers	Provides audio output.

\*Headphone usage is not supported for the audio line out connector.

\*\*To avoid signal interference, when a wireless USB device has been connected to a USB downstream port, it is NOT recommended to connect any other USB devices to the adjacent port(s).



## Monitor specifications

Model	U3824DW
Screen type	Active matrix - TFT LCD
Panel technology	In-Plane Switching Technology
Aspect ratio	21:9
Viewable image	
Diagonal	952.90 mm (37.52 in.)
Horizontal (active area)	879.67 mm (34.63 in.)
Vertical (active area)	366.53 mm (14.43 in.)
Area	322423 mm <sup>2</sup> (499.71 in. <sup>2</sup> )
Pixel pitch	0.22908 mm x 0.22908 mm
Pixel per inch (PPI)	110.87
Viewing angle	178° (vertical) typical 178° (horizontal) typical
Luminance output	300 cd/m <sup>2</sup> (typical)
Contrast ratio	2000 to 1 (typical)
Faceplate coating	Anti-Glare with 3H hardness
Backlight	White LED edgelight system
Response time	8 ms (Normal) 5 ms (Fast)
Curvature	R2300 (typical)
Color depth	1.07 billion colors
Color gamut	<ul style="list-style-type: none"> <li>• DCI-P3 98%</li> <li>• Display P3 98%</li> <li>• sRGB 100%</li> <li>• Rec 709 100%</li> </ul>
Calibration accuracy	DCI-P3, Display P3, sRGB & Rec 709: Delta E < 2 (average)



Connectivity	<ul style="list-style-type: none"> <li>• 1 x DP 1.4 (HDCP2.2) (supports up to WQHD+ 3840 x 1600 60 Hz)</li> <li>• 2 x HDMI port (HDCP2.2) (supports up to WQHD+ 3840 x 1600 60 Hz TMDS as per specified in HDMI 2.1)</li> <li>• 1 x USB Type-C upstream port (video and data) (Alternate mode with DisplayPort 1.4, Power Delivery PD up to 90 W)*</li> <li>• 1 x USB-C upstream port (data only, 10 Gbps USB 3.2 Gen2)</li> <li>• 4 x Super speed USB 10 Gbps (USB 3.2 Gen2) Type-A downstream port</li> <li>• 2 x Super speed USB 10 Gbps (USB 3.2 Gen2) Type-C downstream port with charging capability at 15 W (maximum)</li> <li>• 1 x Super speed USB 10 Gbps (USB 3.2 Gen2) Type-A with BC1.2 charging capability at 2 A (maximum)</li> <li>• 1 x Audio line-out port</li> <li>• 1 x RJ45 2.5G port</li> </ul>
Border width (edge of monitor to active area)	10.50 mm (Top) 9.97 mm (Left/Right) 15.30 mm (Bottom)
Adjustability	
Height adjustable stand	120 mm
Tilt	-5° to 21°
Swivel	-30° to 30°
Slant adjust	-4° to 4°
<b>NOTE:</b> Do not mount or use this monitor in portrait (vertical) orientation or inverse (180°) landscape mount as it may damage the monitor.	
Built-in speakers	2 x 9 W sound output
Dell Display Manager compatibility	Easy Arrange and other key features





Security	Security-lock slot (cable lock sold separately)
----------	---

\*DisplayPort and USB Type-C (Alternate mode with DisplayPort 1.4): HBR3/ DisplayPort 1.4/DP audio is supported.

### Resolution specifications

Model	U3824DW
Horizontal scan range	30 kHz to 100 kHz (automatic)
Vertical scan range	56 Hz to 76 Hz (automatic)
Maximum preset resolution	3840 x 1600 at 60 Hz

### Supported video modes

Model	U3824DW
Video display capabilities (HDMI & DisplayPort & USB Type-C alternate mode)	480p, 576p, 720p, 1080i*, 1080p

\*Supported by HDMI input only.



## Preset display modes

Display mode	Horizontal frequency (kHz)	Vertical frequency (Hz)	Pixel clock (MHz)	Sync polarity (Horizontal /Vertical)
VESA, 640 x 480	31.5	59.9	25.2	-/-
VESA, 640 x 480	37.5	75.0	31.5	-/-
VESA, 720 x 400	31.5	70.1	28.3	-/+
VESA, 800 x 600	37.9	60.3	40.0	+/+
VESA, 800 x 600	46.9	75.0	49.5	+/+
VESA, 1024 x 768	48.4	60.0	65.0	-/-
VESA, 1024 x 768	60.0	75.0	78.8	+/+
VESA, 1152 x 864	67.5	75.0	108.0	+/+
VESA, 1280 x 800 - R	49.3	59.9	71.0	+/-
VESA, 1280 x 1024	64.0	60.0	108.0	+/+
VESA, 1280 x 1024	80.0	75.0	135.0	+/+
VESA, 1600 x 1200	75.0	60.0	162.0	+/+
VESA, 1920 x 1080	67.5	60.0	148.5	+/+
VESA, 2560 x 1440	88.8	60.0	241.5	+/-
VESA, 3840 x 1600*	98.8	60.0	395.0	+/-

\*Requires a graphics card that supports HDMI, DP, and USB-C.



## Electrical specifications

Model	U3824DW
Video input signals	<ul style="list-style-type: none"> <li>• HDMI 2.1 (TMDS)*/DisplayPort 1.4**, 600 mV for each differential line, 100 ohm input impedance per differential pair</li> <li>• USB-C DP Input (DP-Alt Mode), 600 mV for each differential line, 90 ohm input impedance per differential pair</li> </ul>
AC input voltage/frequency/current	100 VAC to 240 VAC / 50 Hz or 60 Hz $\pm$ 3 Hz / 3.2 A (typical)
Inrush current	<ul style="list-style-type: none"> <li>• 120 V: 40 A (Max.) at 0°C (cold start)</li> <li>• 240 V: 80 A (Max.) at 0°C (cold start)</li> </ul>
Power consumption	<ul style="list-style-type: none"> <li>• 0.3 W (Off Mode)<sup>1</sup></li> <li>• 0.4 W (Standby Mode)<sup>1</sup></li> <li>• 0.9 W (Networked Standby Mode)<sup>1</sup></li> <li>• 34.8 W (On Mode)<sup>1</sup></li> <li>• 245 W (Max.)<sup>2</sup></li> <li>• 31.47 W (<math>P_{on}</math>)<sup>3</sup></li> <li>• 100.36 kWh (TEC)<sup>3</sup></li> </ul>

\*Supports up to WQHD+ 3840 x 1600 60 Hz TMDS as per specified in HDMI 2.1.

\*\*HBR3/DisplayPort 1.4/DP audio is supported.

<sup>1</sup> As defined in EU 2019/2021 and EU 2019/2013.

<sup>2</sup> Max brightness and contrast setting with maximum power loading on all USB ports.

<sup>3</sup>  $P_{on}$ : Power consumption of On mode as defined in Energy Star 8.0 version.

TEC: Total energy consumption in kWh as defined in Energy Star 8.0 version.

This document is informational only and reflects laboratory performance. Your product may perform differently, depending on the software, components and peripherals you ordered and shall have no obligation to update such information.

Accordingly, the customer should not rely upon this information in making decisions about electrical tolerances or otherwise. No warranty as to accuracy or completeness is expressed or implied.





**NOTE: This monitor is ENERGY STAR certified.**

**This product qualifies for ENERGY STAR in the factory default settings which can be restored by “Factory Reset” function in the OSD menu. Changing the factory default settings or enabling other features may increase power consumption that could exceed the ENERGY STAR specified limit.**



## Physical characteristics

<b>Model</b>	<b>U3824DW</b>
<b>Signal cable type</b>	<ul style="list-style-type: none"> <li>• Digital: DisplayPort, 20 pins</li> <li>• Digital: HDMI, 19 pins</li> <li>• Universal Series Bus: Type-C, 24 pins</li> <li>• Universal Serial Bus: USB-C to USB-A</li> </ul>
<b>NOTE:</b> Dell monitors are designed to work optimally with the video cables that are shipped with your monitor. As Dell does not have control over the different cable suppliers in the market, the type of material, connector and process used to manufacture these cables, Dell does not guarantee video performance on cables that are not shipped with your Dell monitor.	
<b>Dimensions (with stand)</b>	
Height (extended)	563.76 mm (22.20 in.)
Height (compressed)	443.76 mm (17.47 in.)
Width	894.26 mm (35.21 in.)
Depth	251.21 mm (9.89 in.)
<b>Dimensions (without stand)</b>	
Height	392.33 mm (15.44 in.)
Width	894.26 mm (35.21 in.)
Depth	102.35 mm (4.03 in.)
<b>Stand dimensions</b>	
Height (extended)	438.30 mm (17.26 in.)
Height (compressed)	391.50 mm (15.41 in.)
Width	384.97 mm (15.16 in.)



Depth	251.21 mm (9.89 in.)
Base	384.97 mm (15.16 in) x 247.92 mm (9.76 in.)
<b>Weight</b>	
Weight with packaging	18.98 kg (41.83 lb)
Weight with stand assembly and cables	13.27 kg (29.25 lb)
Weight without stand assembly (For wall mount or VESA mount considerations - no cables)	8.79 kg (19.37 lb)
Weight of stand assembly	4.06 kg (8.95 lb)

## Environmental characteristics

<b>Model</b>	<b>U3824DW</b>
<b>Compliant standards</b>	
<ul style="list-style-type: none"> <li>· ENERGY STAR certified monitor</li> <li>· EPEAT registered where applicable. EPEAT registration varies by country. See <a href="http://www.epeat.net">www.epeat.net</a> for registration status by country.</li> <li>· RoHS-compliant</li> <li>· TCO Certified &amp; TCO Certified Edge</li> <li>· BFR/PVC free monitor (excluding external cables)</li> <li>· Arsenic-free glass and Mercury-free for the panel only</li> </ul>	
<b>Temperature</b>	
Operating	0°C to 40°C (32°F to 104°F)
Non-operating	<ul style="list-style-type: none"> <li>· Storage: -20°C to 60°C (-4°F to 140°F)</li> <li>· Shipping: -20°C to 60°C (-4°F to 140°F)</li> </ul>
<b>Humidity</b>	
Operating	10% to 80% (non-condensing)
Non-operating	<ul style="list-style-type: none"> <li>· Storage: 5% to 90% (non-condensing)</li> <li>· Shipping: 5% to 90% (non-condensing)</li> </ul>
<b>Altitude</b>	
Operating	5000 m (16404 ft) (maximum)



Non-operating	12192 m (40000 ft) (maximum)
<b>Thermal dissipation</b>	<ul style="list-style-type: none"> <li>• 835.97 BTU/hour (maximum)</li> <li>• 118.74 BTU/hour (typical)</li> </ul>

## Pin assignments

### DisplayPort connector

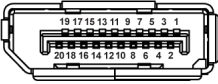

Pin number	20-pin side of the connected signal cable
<b>1</b>	ML3 (n)
<b>2</b>	GND
<b>3</b>	ML3 (p)
<b>4</b>	ML2 (n)
<b>5</b>	GND
<b>6</b>	ML2 (p)
<b>7</b>	ML1 (n)
<b>8</b>	GND
<b>9</b>	ML1 (p)
<b>10</b>	ML0 (n)
<b>11</b>	GND
<b>12</b>	ML0 (p)
<b>13</b>	GND
<b>14</b>	GND
<b>15</b>	AUX (p)
<b>16</b>	GND
<b>17</b>	AUX (n)
<b>18</b>	Hot Plug Detect
<b>19</b>	Re-PWR
<b>20</b>	+3.3 V DP_PWR



## HDMI connector

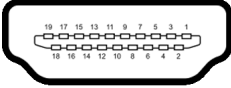

Pin number	19-pin side of the connected signal cable
1	TMDS DATA 2+
2	TMDS DATA 2 SHIELD
3	TMDS DATA 2-
4	TMDS DATA 1+
5	TMDS DATA 1 SHIELD
6	TMDS DATA 1-
7	TMDS DATA 0+
8	TMDS DATA 0 SHIELD
9	TMDS DATA 0-
10	TMDS CLOCK+
11	TMDS CLOCK SHIELD
12	TMDS CLOCK-
13	CEC
14	Reserved (N.C. on device)
15	DDC CLOCK (SCL)
16	DDC DATA (SDA)
17	DDC/CEC Ground
18	+5 V POWER
19	HOT PLUG DETECT



## Universal Serial Bus (USB) interface

This section gives you information about the USB ports that are available on the monitor.

### Super speed USB 10 Gbps (USB 3.2 Gen2)

Transfer speed	Data rate	Maximum power supported*
Super speed	10 Gbps	4.5 W
High speed	480 Mbps	4.5 W
Full speed	12 Mbps	4.5 W

\*Up to 2 A on USB downstream port (with  battery icon) with BC1.2 compliance devices or normal USB devices.

 **NOTE: This monitor is super speed USB 10 Gbps (USB 3.2 Gen2) compatible.**

### USB Type-C

USB Type-C	Description
Video	DisplayPort 1.4*
Data	Super speed USB 10 Gbps (USB 3.2 Gen2)
Power Delivery (PD)	Up to 90 W

\*HBR3/DisplayPort 1.4/DP audio is supported.





## USB 3.2 downstream connector



(Rear)

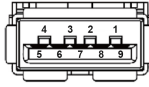

(Bottom)

Pin number	Signal name
1	VBUS
2	D-
3	D+
4	GND
5	StdA_SSRX-
6	StdA_SSRX+
7	GND_DRAIN
8	StdA_SSTX-
9	StdA_SSTX+
Shell	Shield

## USB Type-C connector

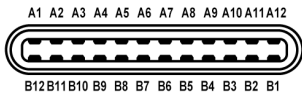

Pin number	Signal name	Pin number	Signal name
A1	GND	B1	GND
A2	TX1+	B2	TX2+
A3	TX1-	B3	TX2-
A4	VBUS	B4	VBUS
A5	CC1	B5	CC2



A6	D+	B6	D+
A7	D-	B7	D-
A8	SBU1	B8	SBU2
A9	VBUS	B9	VBUS
A10	RX2-	B10	RX1-
A11	RX2+	B11	RX1+
A12	GND	B12	GND

## USB ports

- 1 super speed USB 10 Gbps (USB 3.2 Gen2) Type-C upstream (video and data) - rear
- 1 super speed USB 10 Gbps (USB 3.2 Gen2) Type-C upstream (data only) - rear
- 2 super speed USB 10 Gbps (USB 3.2 Gen2) Type-C downstream - bottom
- 5 super speed USB 10 Gbps (USB 3.2 Gen2) Type-A downstream - rear (4) and bottom (1)

Power Charging Port - the port with  battery icon; supports up to 2 A fast-charging capability if the device is BC1.2 compatible.

 **NOTE: Super speed USB 10 Gbps (USB 3.2 Gen2) functionality requires a super speed USB 10 Gbps (USB 3.2 Gen2)-capable computer.**

 **NOTE: The USB ports on the monitor work only when the monitor is turned On or in Standby mode. If you turn Off the monitor and then turn it On, the attached peripherals may take a few seconds to resume normal functionality.**



# RJ45 connector

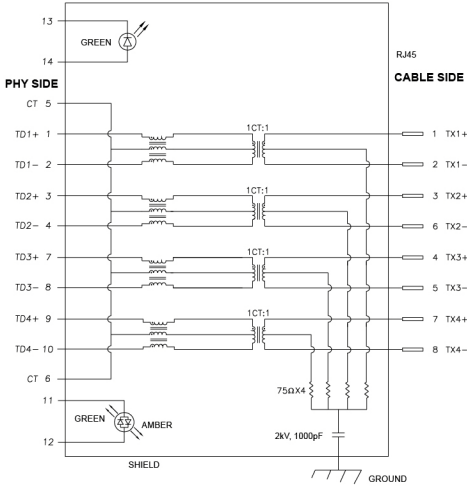

Pin number	Signal	
1	MDI0+	
2	MDI0-	
3	MDI1+	
4	MDI1-	
5	CT	
6	CT	
7	MDI2+	
8	MDI2-	
9	MDI3+	
10	MDI3-	
Pin number	Amber	Green
11	-	+
12	+	-
13	N/A	+
14	N/A	-



## Driver installation

Install the Realtek USB GBE Ethernet Controller Driver available for your system. This is available for download at [www.dell.com/support](http://www.dell.com/support) under the “Driver and download” section.

Network (RJ45) data rate through USB-C max speed is 2500 Mbps.

## Wake-on-LAN behavior

Computer power save state	System behavior after receiving Wake-on-Lan (WOL) command
Modern Standby (S0ix)	Computer and Monitor remain in Standby mode but the network communication is enabled.
Standby/Sleep (S3)	Both the Computer and Monitor are turned ON.
Hibernate (S4)	Both the Computer and Monitor are turned ON.
OFF/Shutdown (S5)	Both the Computer and Monitor are turned ON.

 **NOTE: The computer BIOS must be configured to enable WOL function first.**

 **NOTE: This LAN port is 1000Base-T IEEE 802.3az compliant, supporting Mac Address (Printed on model label) Pass-thru (MAPT), Wake-on-LAN (WOL) from standby mode (S3) and UEFI\* PXE Boot function [UEFI PXE Boot is not supported on Dell Desktop PC's (except for OptiPlex 7090/3090 Ultra Desktop)], these 3 features depend on BIOS settings and version of the OS. Functionality may vary with non-Dell PC's.**

\*UEFI stands for Unified Extensible Firmware Interface.

 **NOTE: WOL S4 and WOL S5 are only capable with Dell Systems that support DPBS and is with USB-C connection only.**

 **NOTE: Any issue related to WOL, user should debug the computer without the monitor. After the problem is solved, then connect to the Monitor.**



## RJ45 connector LED status

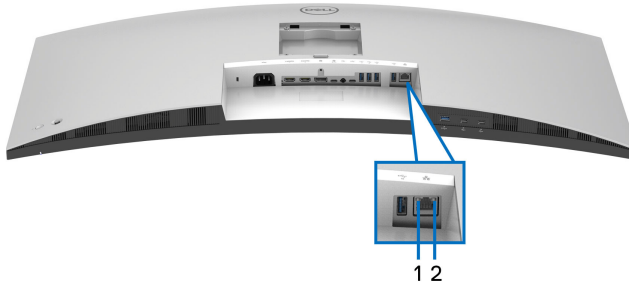

Label	LED color	Description
1	Green	Link/Activity indicator: <ul style="list-style-type: none"><li>• Blinking - Activity on the port.</li><li>• Green On - Link is being established.</li><li>• Off - Link is not established.</li></ul>
2	Amber or Green	Speed indicator: <ul style="list-style-type: none"><li>• Amber On - 1000 Mbps/2500 Mbps</li><li>• Green On - 100 Mbps</li><li>• Off - 10 Mbps</li></ul>

 **NOTE: The RJ45 cable is non in-box standard accessory.**



## Video bandwidth

Host	Video cable	USB-C prioritization	Color depth	Resolution
USB-C (Alt Mode DP1.2)	USB-C Gen2 cable	High Data Speed	8 Bits	3840 x 1600 @ 30 Hz
		High Resolution	8 Bits + 2 Bits FRC	3840 x 1600 @ 60 Hz
USB-C (Alt Mode DP1.4)	USB-C Gen2 cable	High Data Speed	8 Bits	3840 x 1600 @ 60 Hz
		High Resolution	8 Bits + 2 Bits FRC	3840 x 1600 @ 60 Hz
HDMI 1.4	HDMI cable	N/A	8 Bits + 2 Bits FRC	3840 x 1600 @ 30 Hz
HDMI 2.1*	HDMI cable	N/A	8 Bits + 2 Bits FRC	3840 x 1600 @ 60 Hz
DP 1.2	DP cable	N/A	8 Bits + 2 Bits FRC	3840 x 1600 @ 60 Hz
DP 1.4	DP cable	N/A	8 Bits + 2 Bits FRC	3840 x 1600 @ 60 Hz

\*Supports up to WQHD+ 3840 x 1600 60Hz TMDS as per specified in HDMI 2.1.



## USB speed bandwidth

Host	USB upstream cable	USB-C prioritization	USB device connected to USB-A or C downstream
USB-C (Alt Mode DP1.2)	USB-C Gen2 cable	High Data Speed	Supported, USB 2.0/3.2 Gen2
		High Resolution	Supported, USB 2.0
USB-C (Alt Mode DP1.4)	USB-C Gen2 cable	High Data Speed	Supported, USB 2.0/3.2 Gen2
		High Resolution	Supported, USB 2.0
USB-A 2.0	USB A - C cable	N/A	Supported, USB 2.0
USB-A 3.2 Gen1	USB A - C cable	N/A	Supported, USB 2.0/3.2 Gen1
USB-C 3.2 Gen1 (Data only)	USB-C Gen2 cable	N/A	Supported, USB 2.0/3.2 Gen1
USB-C 3.2 Gen2 (Data only)	USB-C Gen2 cable	N/A	Supported, USB 2.0/3.2 Gen2

## Plug and play capability

You can connect the monitor to any Plug and Play-compatible system. The monitor automatically provides the computer with its Extended Display Identification Data (EDID) using Display Data Channel (DDC) protocols so that the computer can configure itself and optimize the monitor settings. Most monitor installations are automatic; you can select different settings as required. For more information about changing the monitor settings, see [Operating the monitor](#).

## LCD monitor quality and pixel policy

During the LCD Monitor manufacturing process, it is not uncommon for one or more pixels to become fixed in an unchanging state which are hard to see and do not affect the display quality or usability. For more information on Dell Monitor Quality and Pixel Policy, see [www.dell.com/pixelguidelines](http://www.dell.com/pixelguidelines).



## Ergonomics

△ **CAUTION: Improper or prolonged usage of keyboard may result in injury.**

△ **CAUTION: Viewing the monitor screen for extended periods of time may result in eye strain.**

For comfort and efficiency, observe the following guidelines when setting up and using your computer workstation:

- Position your computer so that the monitor and keyboard are directly in front of you as you work. Special shelves are commercially available to help you correctly position your keyboard.
- To reduce the risk of eye strain and neck, arm, back, or shoulder pain from using the monitor for long period, we recommend you to:
  1. Set the distance of the screen between 20 to 28 in. (50 - 70 cm) from your eyes.
  2. Blink frequently to moisten your eyes or wet your eyes with water after prolonged usage of the monitor.
  3. Take regular and frequent breaks for 20 minutes every two hours.
  4. Look away from your monitor and gaze at a distant object that is 20 feet away for at least 20 seconds during the breaks.
  5. Perform stretches to relieve tension in the neck, arm, back, and shoulders during the breaks.
- Ensure that the monitor screen is at eye level or slightly lower when you are sitting in front of the monitor.
- Adjust the tilt of the monitor, its contrast, and brightness settings.
- Adjust the ambient lighting around you (such as overhead lights, desk lamps, and the curtains or blinds on nearby windows) to minimize reflections and glare on the monitor screen.
- Use a chair that provides good lower-back support.
- Keep your forearms horizontal with your wrists in a neutral, comfortable position while using the keyboard or mouse.
- Always leave space to rest your hands while using the keyboard or mouse.
- Let your upper arms rest naturally on both sides.
- Ensure that your feet are resting flat on the floor.





- When sitting, make sure that the weight of your legs is on your feet and not on the front portion of your seat. Adjust your chair's height or use a footrest if necessary, to maintain a proper posture.
- Vary your work activities. Try to organize your work so that you do not have to sit and work for extended periods of time. Try to stand or get up and walk around at regular intervals.
- Keep the area under your desk clear of obstructions and cables or power cords that may interfere with comfortable seating or present a potential trip hazard.

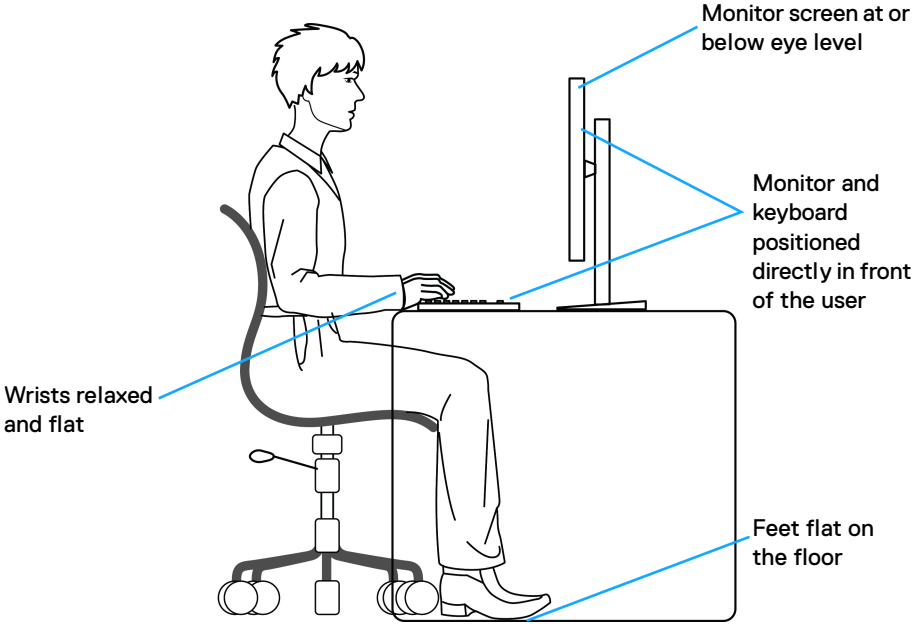

## Handling and moving your display

To ensure that the monitor is handled safely when lifting or moving it, follow these guidelines:

- Before moving or lifting the monitor, turn off your computer and the monitor.
- Disconnect all cables from the monitor.
- Place the monitor in the original box with the original packing materials.
- Hold the bottom edge and the side of the monitor firmly without applying excessive pressure when lifting or moving the monitor.

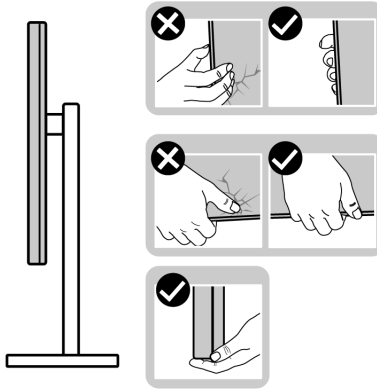

- When lifting or moving the monitor, ensure the screen is facing away from you and do not press on the display area to avoid any scratches or damage.

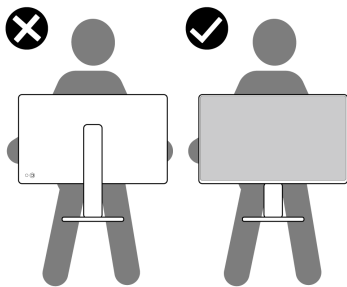

- When transporting the monitor, avoid any sudden shock or vibration to it.



- When lifting or moving the monitor, do not turn the monitor upside down while holding the stand base or stand riser. This may result in accidental damage to the monitor or cause personal injury.

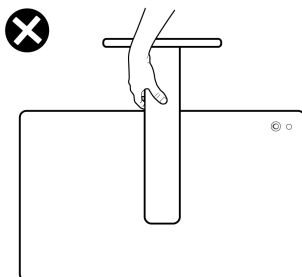

## Maintenance guidelines

### Cleaning your monitor

- ⚠ **WARNING:** Using improper methods when cleaning the monitor can result in a physical damage to the screen or the body of your Dell monitor.
- ⚠ **CAUTION:** Read and follow the [Safety instructions](#) before cleaning the monitor.
- ⚠ **WARNING:** Before cleaning the monitor, unplug the monitor power cable from the electrical outlet.

For best practices, follow the instructions in the list below when unpacking, cleaning, or handling your monitor:

- To clean the Dell monitor screen, lightly dampen a soft, clean cloth with water. If possible, use a special screen-cleaning tissue or solution suitable for the Dell monitor screen.
- ⚠ **CAUTION:** Do not use detergents or other chemicals such as benzene, thinner, ammonia, abrasive cleaners, or compressed air.
- ⚠ **CAUTION:** Using chemicals for cleaning may cause changes in the appearance of the monitor, such as color fading, milky film on the monitor, deformation, uneven dark shade, and peeling of screen area.



 **WARNING: Do not spray the cleaning solution or even water directly on the surface of the monitor. Doing so will allow liquids to accumulate at the bottom of the display panel and corrode the electronics resulting in permanent damage. Instead, apply the cleaning solution or water to a soft cloth and then clean the monitor.**



 **NOTE: Monitor damage due to improper cleaning methods and the use of benzene, thinner, ammonia, abrasive cleaners, alcohol, compressed air, detergent of any kind will lead to a Customer Induced Damage (CID). CID is not covered under the standard Dell warranty.**

- If you notice white powder when you unpack your monitor, wipe it off with a cloth.
- Handle your monitor with care as a darker-colored monitor may get scratched and show white scuff marks more than a lighter-colored monitor.
- To help maintain the best image quality on your monitor, use a dynamically changing screen saver and turn off your monitor when not in use.



# Setting up the monitor

## Attaching the stand

-  **NOTE:** The stand is not installed at the factory when shipped.
-  **NOTE:** The following instructions are applicable only for the stand that was shipped with your monitor. If you are attaching a stand that you purchased from any other source, follow the setup instructions that were included with the stand.

To attach the monitor stand:

1. Remove the stand riser and stand base from the packaging cushion.

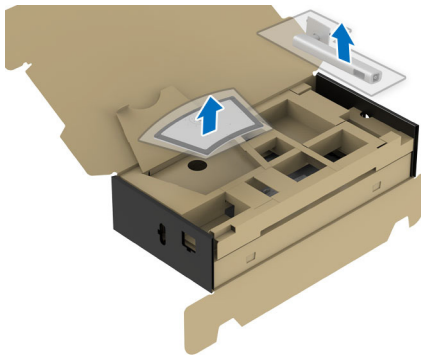

-  **NOTE:** The image is for the purpose of illustration only. The appearance of the package cushion may vary.
2. Insert the stand base blocks fully into the stand slot.
  3. Lift the screw handle and turn the screw clockwise.
  4. After fully tightening the screw, fold the screw handle flat within the recess.



5. Lift the protective cover, as shown, to access the VESA area for stand assembly.

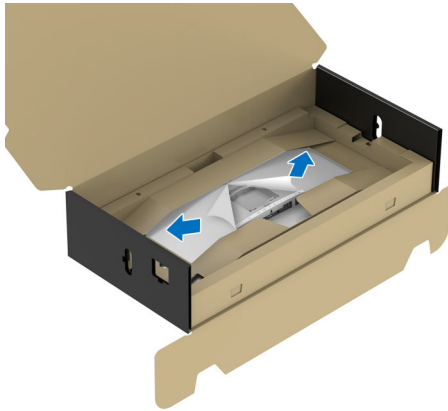

**NOTE:** Before attaching the stand assembly to the display, ensure that the front plate flap is opened to allow space for assembly.

6. Attach the stand assembly to the display.
  - a. Fit the two tabs on the upper part of the stand to the groove on the back of the display.
  - b. Press the stand down till it snaps into place.

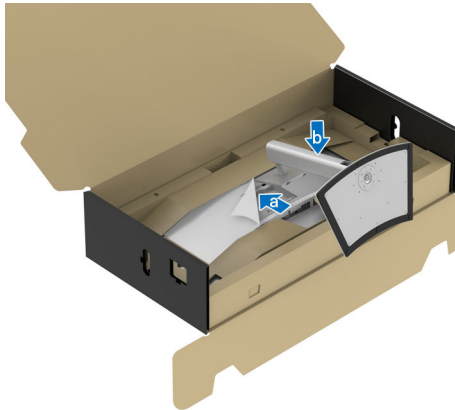

7. Place the monitor upright with the protective cushion attached.



**NOTE:** Lift the monitor carefully to prevent it from slipping or falling.



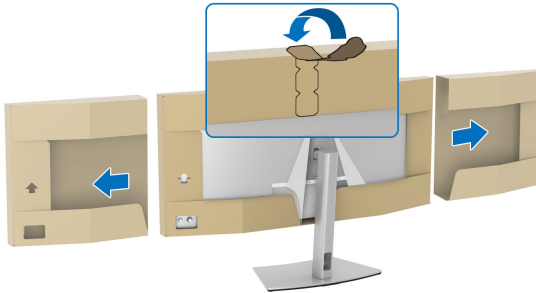

8. Tear apart the zipper die-cut in the middle of the protective cushion, then remove the protective cushion from the left and right side of the monitor.

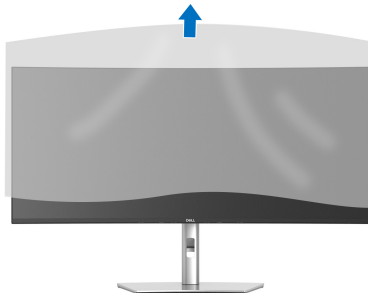

9. Remove the protective cover from the monitor.



## Connecting your monitor

-  **WARNING:** Before you begin any of the procedures in this section, follow the [Safety instructions](#).
-  **NOTE:** Dell monitors are designed to work optimally with the Dell-supplied cables inside the box. Dell does not guarantee the video quality and performance if non-Dell cables are used.
-  **NOTE:** Route the cables through the cable-management slot before connecting them.
-  **NOTE:** Do not connect all the cables to the computer at the same time.
-  **NOTE:** The images are for the purpose of illustration only. The appearance of the computer may vary.

To connect your monitor to the computer:

1. Turn Off your computer and disconnect the power cable.
  2. Connect the DisplayPort, HDMI, or USB Type-C cable from your monitor to the computer.
  3. Plug the power cables for your computer and monitor into a nearby outlet.
-  **CAUTION:** Before using the monitor, it is recommended to fasten the stand riser to a wall using cable tie or a cord that can support the weight of the monitor in order to prevent the monitor from falling.

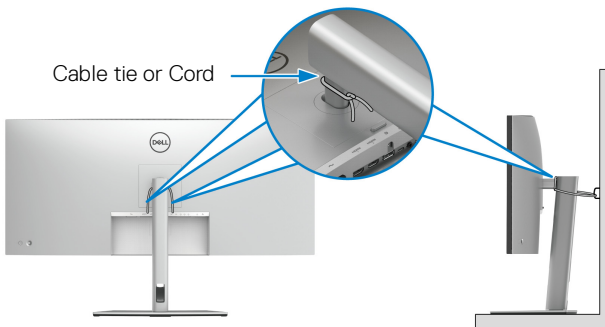

4. Turn On the monitor and the computer.

If your monitor displays an image, installation is complete. If it does not display an image, see [Common problems](#).





## Connecting the DisplayPort (DisplayPort to DisplayPort) cable

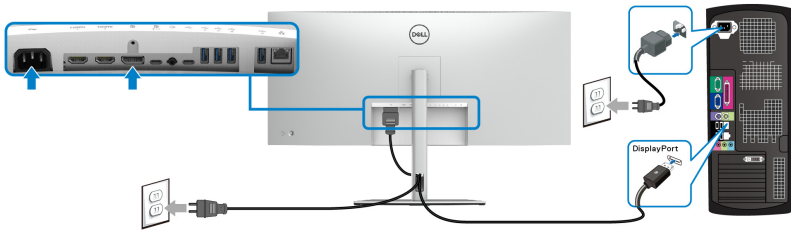

## Connecting the HDMI cable

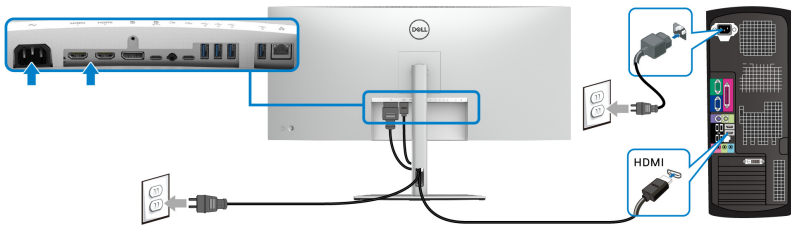

## Connecting the USB Type-C cable (USB-C to USB-C)

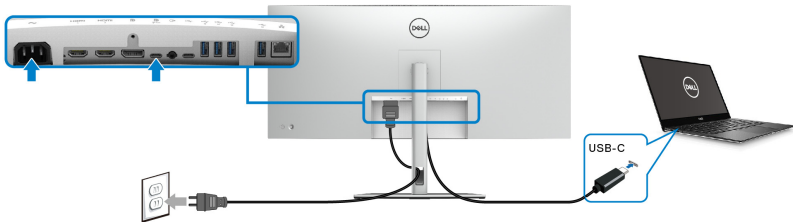

### **NOTE: Use the USB Type-C cable shipped with your monitor only.**

- This port supports DisplayPort Alternate Mode (DP1.4 standard only).
- The USB Type-C power delivery compliant port (PD Version 3.1) delivers up to 90 W of power.
- If your notebook requires more than 90 W to operate and the battery is drained, it may not be powered up or charged with the USB PD port of this monitor.



## Connecting the USB Type-C cable (USB-C to USB-A)

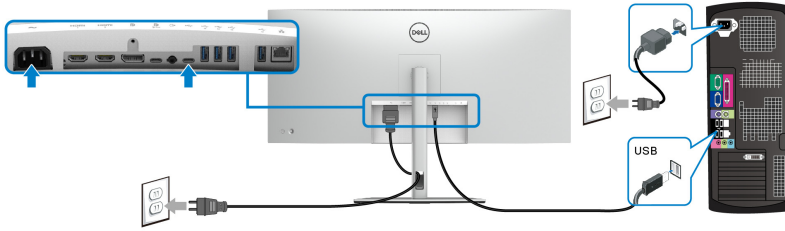

**NOTE:** This connection is for data only.

## Connecting the super speed USB 10 Gbps (USB 3.2 Gen2) cable

**NOTE:** To prevent data damage or loss, before unplugging the USB upstream port, make sure that NO USB storage devices are in use by the computer connected to the monitor's USB downstream port.

After you have completed connecting the DisplayPort/HDMI/USB Type-C cable, follow the procedures below to connect the USB cable(s) to the computer(s) and complete your monitor setup:

- a. Connect one computer:** connect the USB 3.2 (Gen2) Type-C upstream port (data only) to an appropriate USB 3.2 (Gen2) port on your computer with the supplied USB-A to USB-C cable.
- b. Connect two computers\*:** connect the USB 3.2 (Gen2) upstream ports to appropriate USB ports on the two computers with the 2 supplied USB cables. Then use the OSD menu to select between the USB and input sources. See [USB](#).
2. Connect the USB peripherals to the USB downstream ports on the monitor.
3. Plug the power cables for your computer(s) and monitor into a nearby outlet.

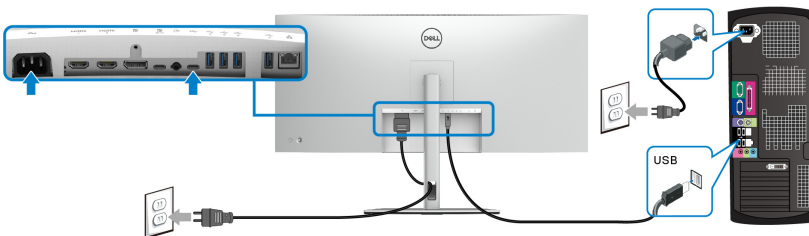

**a. Connect one computer**



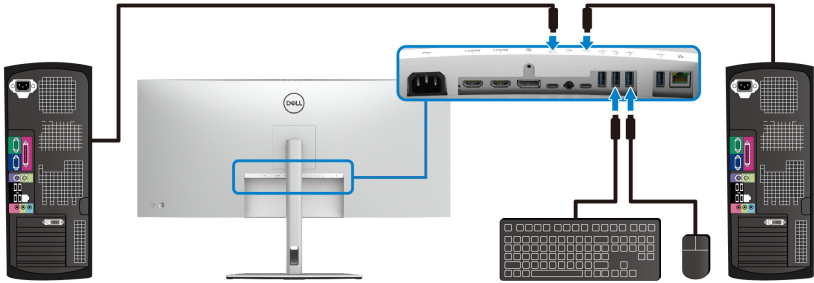

### b. Connect two computers

\*When connecting two computers to the monitor, configure the **USB** settings from the OSD menu to share a single set of keyboard and mouse connected to the monitor between two computers. See [USB](#) and [Setting the KVM switch](#) for details.

### Connecting the monitor for RJ45 cable (optional)

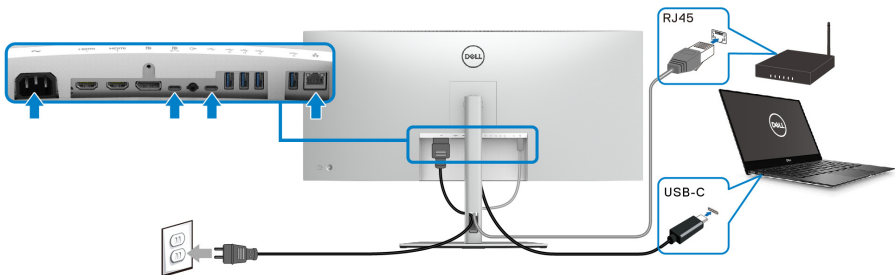

**NOTE:** The RJ45 cable is not an in-box standard accessory.



## Dell Power Button Sync (DPBS)

Your monitor is designed with Dell Power Button Sync (DPBS) feature to allow you to control PC system power state from the monitor power button. This feature is only supported with Dell platform which has built-in DPBS function, and is only supported over USB-C interface.

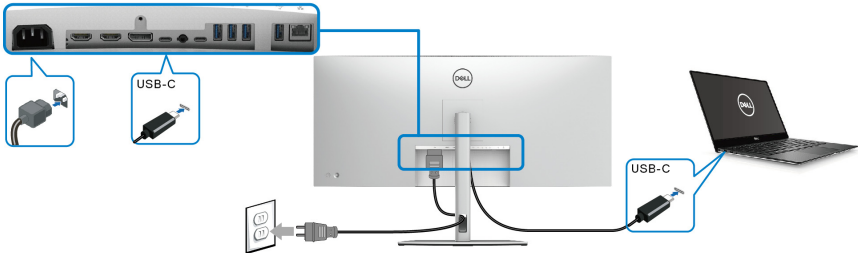

To make sure the DPBS function works for the first time, perform the following steps on the DPBS supported platform in the **Control Panel** first.

**NOTE:** DPBS only supports the USB Type-C upstream port with  icon.

### 1. Go to **Control Panel**.

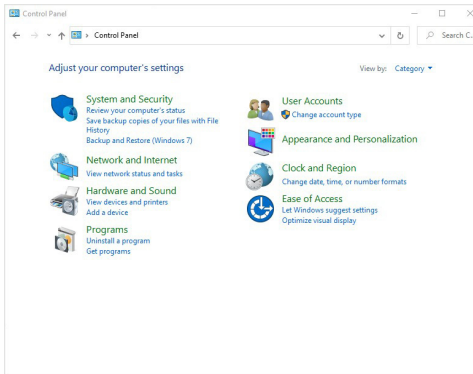

## 2. Select **Hardware and Sound**, followed by **Power Options**.

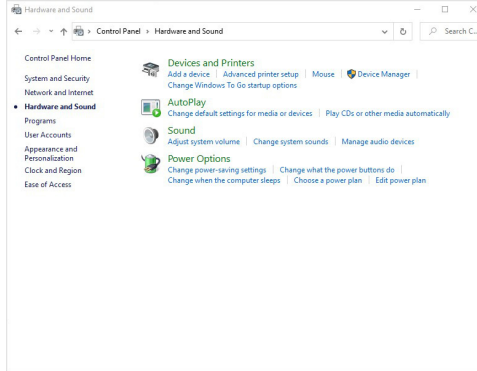

## 3. Go to **System Settings**.

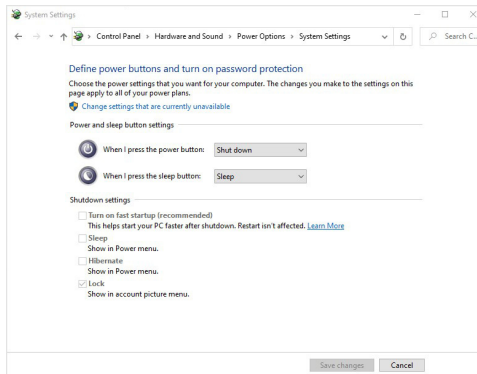

4. In the drop-down menu of **When I press the power button**, there are a few options for selection, namely **Do nothing/Sleep/Hibernate/Shut down**. You can select **Sleep/Hibernate/Shut down**.

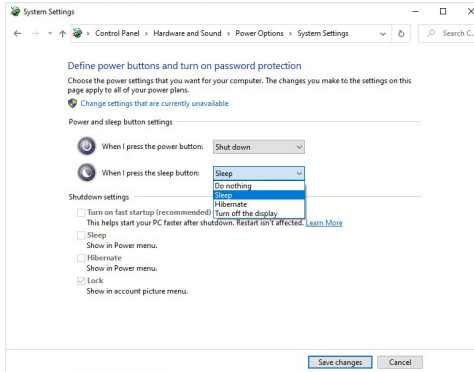
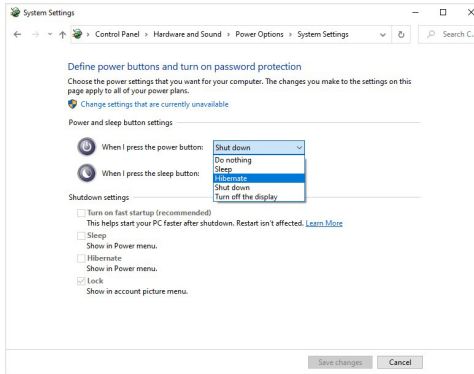

**NOTE:** Do not select “Do nothing”, otherwise the monitor power button will not be able to sync with PC system power state.



## Connecting the monitor for DPBS for the first time

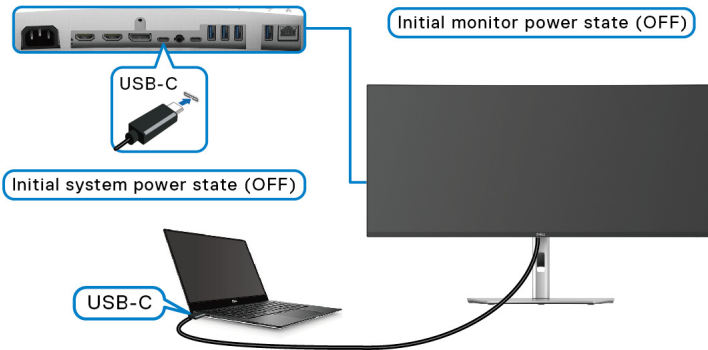

For the first time setting up the DPBS function:

1. Make sure both the PC and the monitor are OFF.
2. Press the monitor power button to turn ON the monitor.
3. Connect the USB-C cable from the PC to the monitor.
4. Both the monitor and PC will turn ON normally. If not, press either the monitor power button or PC power button to boot up the system.

 **NOTE:** Ensure that Dell Power Button Sync is set to On. See [Dell Power Button Sync](#).



## Using DPBS function

### Waking on the USB-C cable

When you connect the USB-C cable, the Monitor/PC state is as follows:

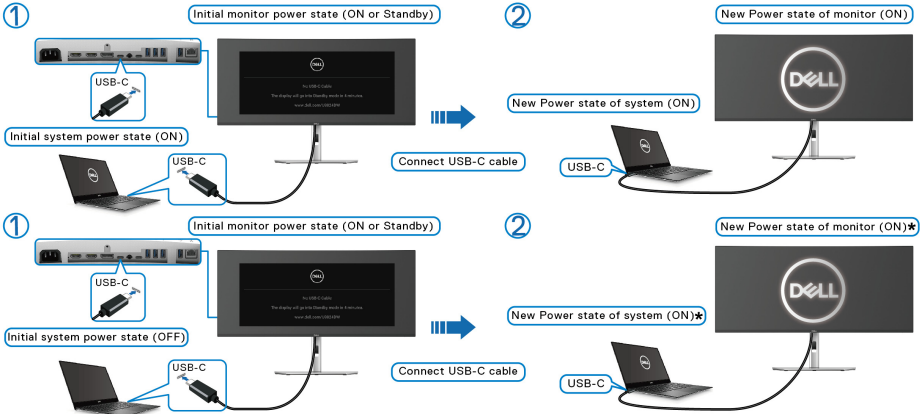

\* Not all Dell PC systems support to wake up the platform through the monitor.

\* Upon USB-C cable connection, mouse movement or keyboard press might be required to wake the system/monitor up from sleep or hibernate.

When you press the monitor power button or PC power button, the Monitor/PC state is as follows:

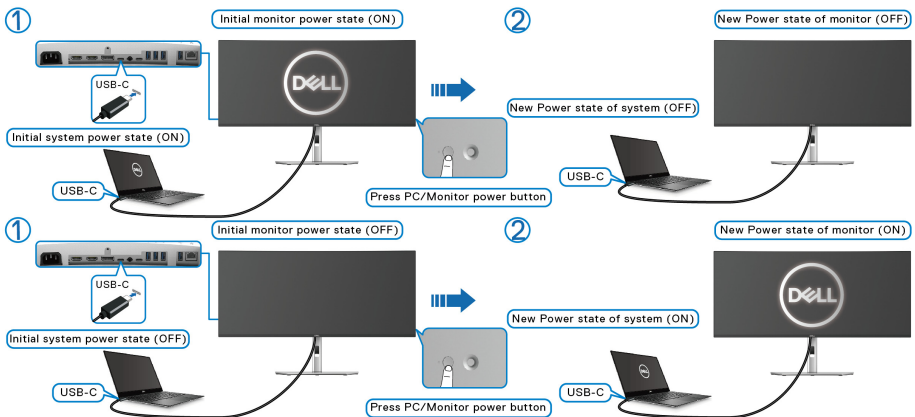



**NOTE: You can enable or disable the Dell Power Button Sync function using the OSD.**

- When the monitor and the PC power state are both ON, **press and hold the monitor power button for 4 seconds**, the screen prompt will ask if you would like to shut down the PC.

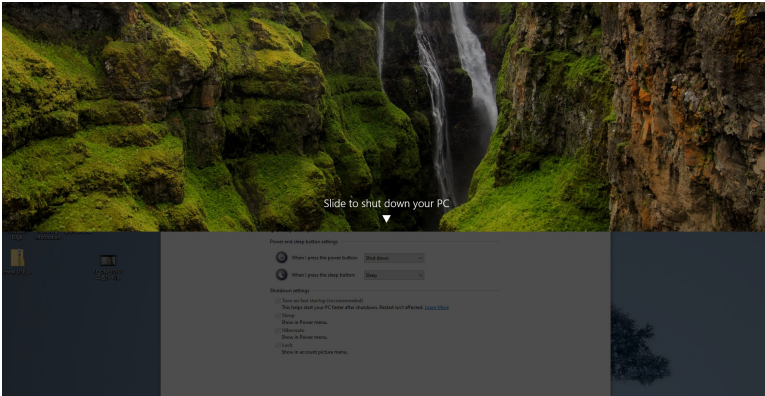
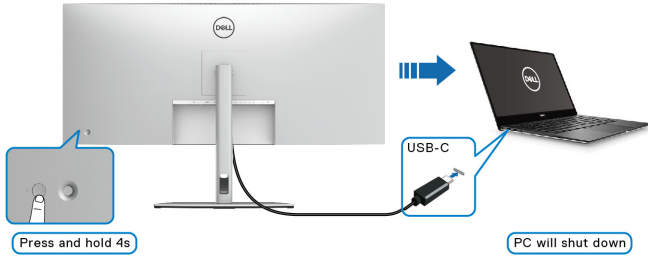

- When it is necessary to force shut down the system, **press and hold the monitor power button for 10 seconds**.

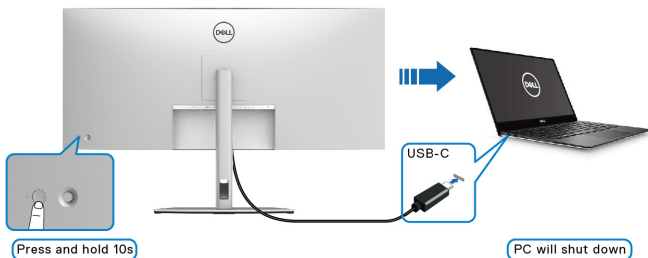

## Connecting the monitor for USB-C

If the Dell PC\* has more than two USB-C ports, the power state of each connected monitor will sync with the PC.

For example, when the PC and two monitors are in an initial ON power state, pressing the power button on Monitor 1 or Monitor 2 will turn OFF the PC, Monitor 1, and Monitor 2.

\*Ensure to check the Dell PC for DPBS support.

**NOTE: DPBS only supports the USB Type-C upstream port with  icon.**

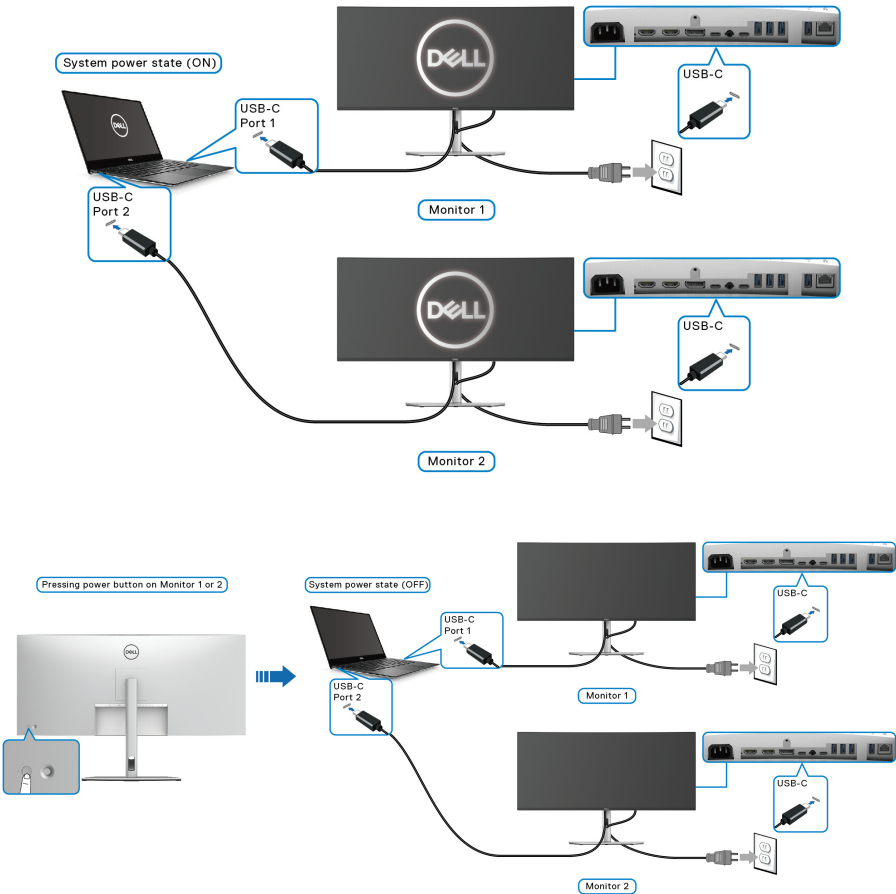

Ensure that **Dell Power Button Sync** is set to **On** (see [Dell Power Button Sync](#)). When the PC and two monitors are in an initial OFF power state, pressing the power button on Monitor 1 or Monitor 2 will turn ON the PC, Monitor 1, and Monitor 2.

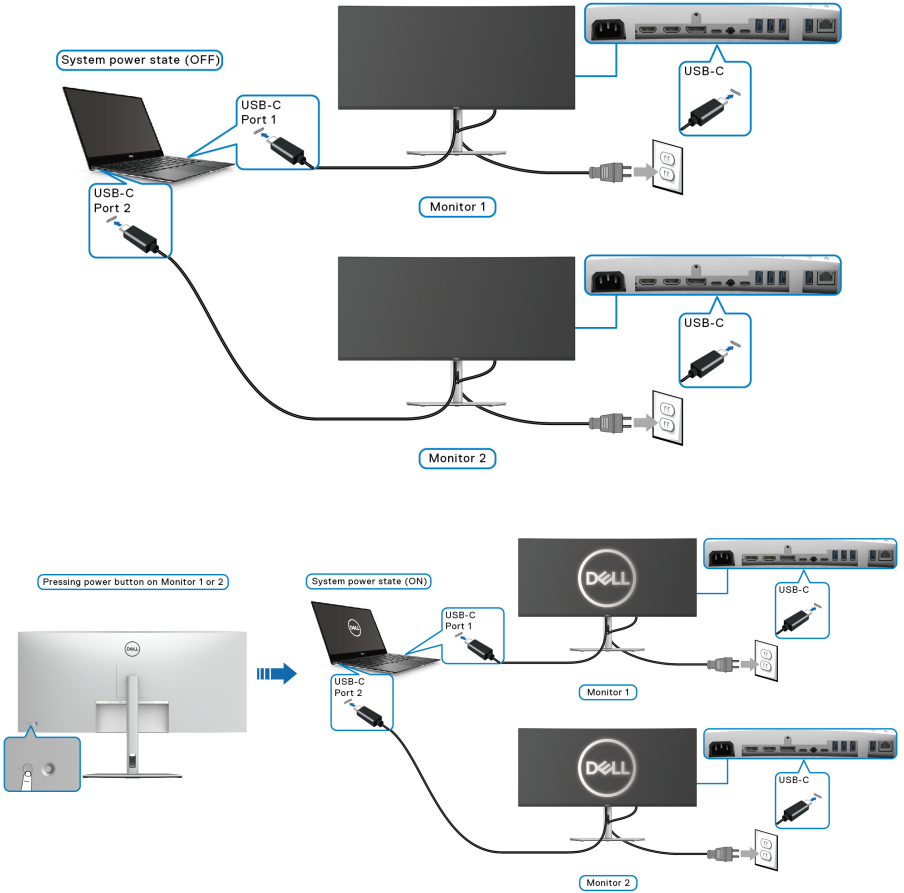

## Organizing your cables



After attaching all necessary cables to your monitor and computer (see [Connecting your monitor](#) for cable attachment), organize all cables as shown above.

## Securing your monitor using Kensington lock (optional)

The security-lock slot is located at the bottom of the monitor (see [Security-lock slot](#)). Secure your monitor to a table using the Kensington security lock.

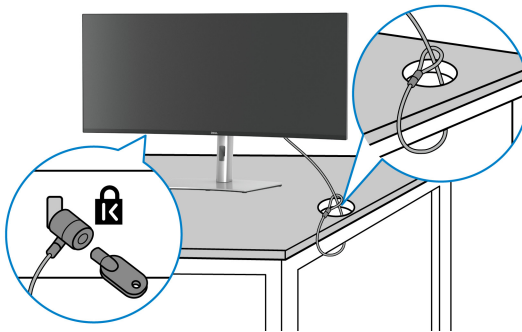

For more information on using the Kensington lock (sold separately), see the documentation that is shipped with the lock.



 **NOTE:** The image is for the purpose of illustration only. The appearance of the lock may vary.



## Removing the monitor stand

-  **NOTE:** To prevent scratches on the LCD screen when removing the stand, ensure that the monitor is placed on a soft surface and handle it carefully.
-  **NOTE:** The following steps are specifically for removing the stand that is shipped with your monitor. If you are removing a stand that you purchased from any other source, follow the setup instructions that are included with the stand.

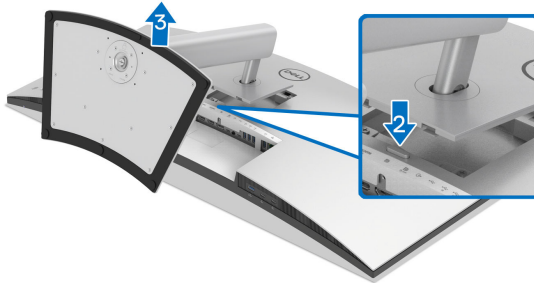

To remove the stand:

1. Place the monitor on a soft cloth or cushion.
2. Press and hold the stand release button at the back of the display.
3. Lift the stand assembly up and away from the monitor.



## VESA wall mounting (optional)

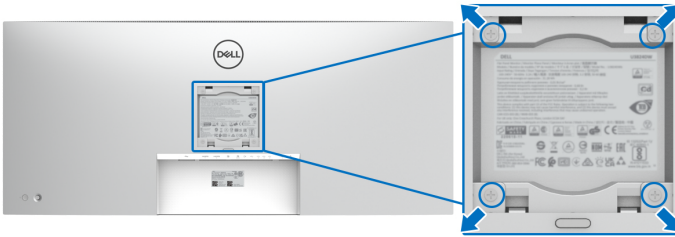

(Screw dimension: M4 x 10 mm).

Refer to the instructions that come with the VESA-compatible wall mounting kit.

1. Place the monitor panel on a soft cloth or cushion on a stable flat table.
2. Remove the stand (see [Removing the monitor stand](#)).
3. Use a Phillips crosshead screwdriver to remove the four screws securing the plastic cover.
4. Attach the mounting bracket from the wall mounting kit to the monitor.
5. Mount the monitor on the wall. For more information, see the documentation that is shipped with the wall mounting kit.

**NOTE:** For use only with UL or CSA or GS-listed wall mount bracket with minimum weight or load bearing capacity of 35.16 kg.



# Operating the monitor

## Power on the monitor

Press the power button to turn on the monitor.

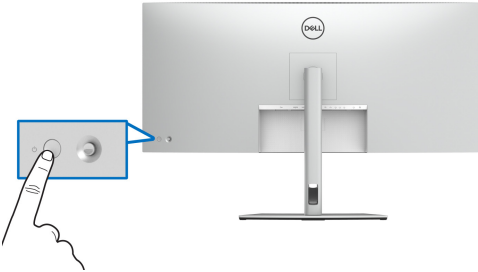

## Using the joystick control

Use the joystick control on the rear of the monitor to make On-Screen Display (OSD) adjustments.

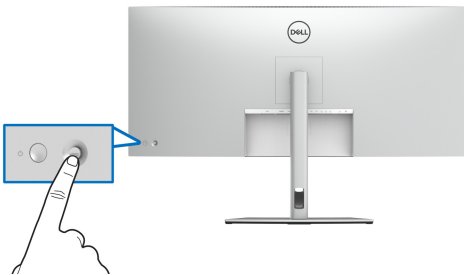

1. Press the joystick to launch the Menu Launcher.
2. Move the joystick up or down or left or right to toggle through options.
3. Press the joystick again to confirm the selection.

---

### Joystick

### Description

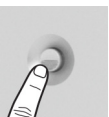

- When there is no OSD on the screen, press the joystick to launch the Menu Launcher. See [Accessing the Menu Launcher](#).
- When the OSD is displayed, press the joystick to confirm the selection or save the settings.



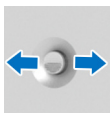

- For 2-way (right and left) directional navigation.
- Move right to enter the submenu.
- Move left to the upper-level menu or exit from the current menu.

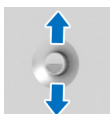

- For 2-way (up and down) directional navigation.
- Toggles between the menu items.
- Increases (up) or decreases (down) the parameters of selected menu item.

## Using the On-Screen Display (OSD) menu

### Accessing the Menu Launcher

When you toggle or press the joystick, the Menu Launcher appears to let you access the OSD main menu and shortcut functions,

To select a function, move the joystick.

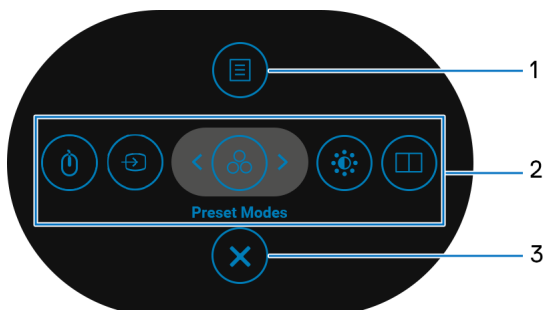

The following table describes the Menu Launcher functions:

Label	Icon	Description
1		To launch the On-Screen Display (OSD) main menu. See <a href="#">Accessing the menu system</a> .
	<b>Menu</b>	





---

2



**Shortcut functions**

When you move the joystick to the left or right to toggle between the shortcut functions, the selected item will be highlighted and shifted to the center position. Press the joystick to enter its submenu.

- **USB Switch:** To switch between the USB upstream sources in PIP/PBP mode.
- **Input Source:** To choose an input source from the list of video signals that may be connected to your monitor.
- **Preset Modes:** To choose a preferred color mode from the list of preset modes.
- **Brightness/Contrast:** To access the adjustment sliders of brightness and contrast.
- **PIP/PBP Mode:** To choose a PBP or PIP mode from the preset list, which provides different sizes and positions of the sub-window.

---

**NOTE:** After you change the settings, press the joystick to save the changes before proceeding to another function or exiting.

---

3



**Exit**

To exit the Menu Launcher.

---

### Using the navigation keys

When the OSD main menu is active, move the joystick to configure the settings, following the navigation keys displayed below the OSD.

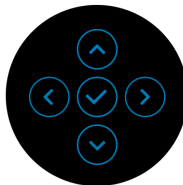



After you change the settings, press the joystick to save the changes before proceeding to another menu or exiting the OSD menu.

 **NOTE:** To exit the current menu item and return to the previous menu, move the joystick to the left until you exit.

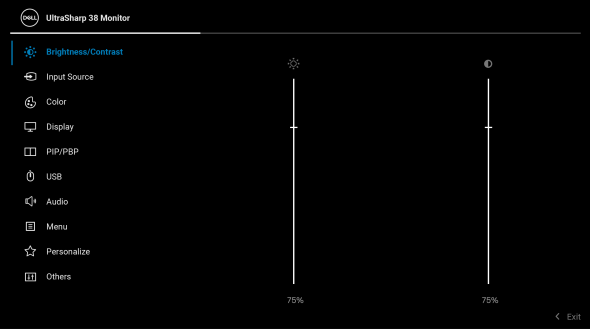

## Accessing the menu system

 **NOTE:** After you change the settings, press the joystick to save the changes before proceeding to another menu or exiting the OSD menu.

Icon	Menu and submenu	Description
	<b>Brightness/Contrast</b>	Adjusts the brightness and the contrast of the display.
		
		
<b>Brightness</b>	<b>Brightness</b> adjusts the luminance of the backlight. Move the joystick up or down to increase or decrease the brightness level (min. 0/max. 100).	
<b>Contrast</b>	Adjust the <b>Brightness</b> first, and then adjust the <b>Contrast</b> only if further adjustment is necessary. Move the joystick up or down to increase or decrease the contrast level (min. 0/max. 100). The <b>Contrast</b> function adjusts the degree of difference between darkness and lightness on the monitor screen.	





## Input Source

Select between the different video signals that may be connected to your monitor.

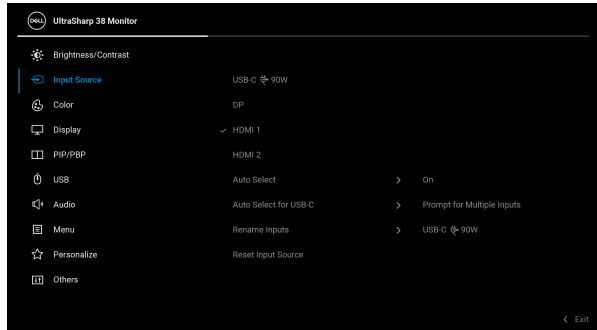

### USB-C 90W

Select **USB-C 90W** when you are using the USB Type-C connector. Press the joystick to confirm the selection.

### DP

Select **DP** when you are using the DisplayPort (DP) connector. Press the joystick to confirm the selection.

### HDMI 1

Select **HDMI 1** when you are using the HDMI 1 connector. Press the joystick to confirm the selection.

### HDMI 2

Select **HDMI 2** when you are using the HDMI 2 connector. Press the joystick to confirm the selection.

### Auto Select

Automatically scans for available input sources. The default is **On**. Press the joystick to confirm the selection.



---

**Auto Select for USB-C**

Allows you to set this function to:

- **Prompt for Multiple Inputs:** Always displays the “**Switch to USB-C Video Input**” message for you to choose whether to switch or not.
- **Yes:** Always switches to USB-C video input (without asking) when the USB Type-C cable is connected.
- **No:** Never automatically switches to USB-C video input when the USB Type-C cable is connected.

Press the joystick to confirm the selection.

**NOTE:** The option is available only when **Auto Select** is on.

---

**Rename Inputs**

Allows you to specify a preset input name for the selected input source. The preset options are **PC**, **PC 1**, **PC 2**, **Laptop**, **Laptop 1**, and **Laptop 2**. The default setting is **Off**.

**NOTE:** When you perform a rename for the USB-C input, the wattage value remains after the specified option, e.g., **PC 1** → **90W**.

**NOTE:** It is not applicable for the input names shown in the warning messages and **Display Info**.

---

**Reset Input Source**

Resets your monitor input settings to the factory settings.

---





## Color

Adjusts the color setting mode.

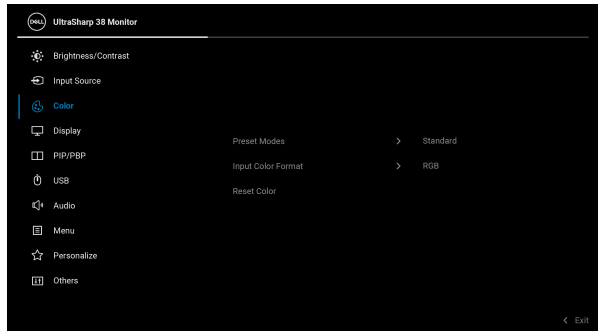

## Preset Modes

Allows you to choose from the list of preset color modes. Press the joystick to confirm the selection.

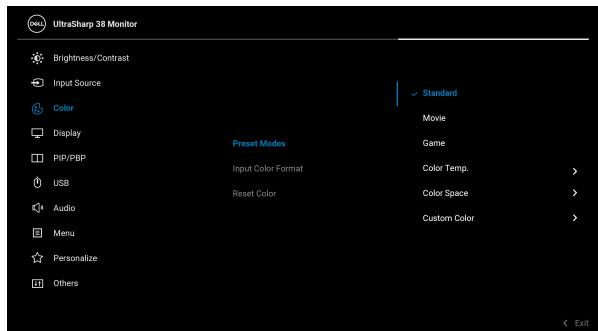

- **Standard:** This is the default setting. Using a low blue light panel, this monitor is certified by TUV to reduce blue light output and create more relaxing and less stimulating images.
- **Movie:** Loads color settings ideal for movies.
- **Game:** Loads color settings ideal for most gaming applications.



---

## Preset Modes

- **Color Temp.:** Allows you to select the color temperature: 5000K, 5700K, 6500K, 7500K, 9300K, and 10000K. Press the joystick to confirm the selection.
- **Color Space:** Allows you to set the color space to:
  - **sRGB:** matches 100% sRGB.
  - **Rec. 709:** matches 100% Rec. 709.
  - **DCI-P3:** reproduces 98% of DCI-P3 digital cinema color standard.
  - **Display P3:** reproduces 98% of Display P3.

**NOTE:** When you select **DCI-P3** as the color space, the luminance of the backlight defaults to 50 cd/m<sup>2</sup> (typical). You can manually adjust the luminance of the backlight by using the **Brightness** function under **Brightness/Contrast** in the OSD menu.

**NOTE:** If you select the color space ICC profile from your PC, the monitor OSD will not change automatically to the respective color space.

- **Custom Color:** Allows you to manually adjust the color settings. Move the joystick to adjust the **Gain, Offset, Hue, and Saturation** settings and create your own preset color mode.
- 



---

## Input Color Format

Allows you to set the video input mode to:

- **RGB**: Select this option if your monitor is connected to a computer or a media player that supports RGB output.
- **YCbCr**: Select this option if your media player supports only YCbCr output.

Press the joystick to confirm the selection.

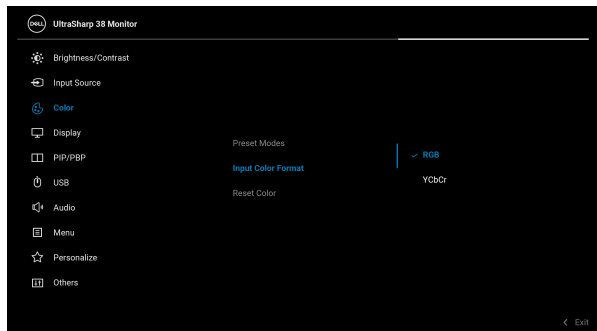

---

## Hue

This feature can shift the color of the video image to green or purple. This is used to adjust the desired flesh tone color. Move the joystick to adjust the hue level from '0' to '100'.

**NOTE:** The feature is available only when you select **Movie** or **Game** preset mode.

---

## Saturation

This feature can adjust the color saturation of the video image. Move the joystick to adjust the saturation level from '0' to '100'.

**NOTE:** The feature is available only when you select **Movie** or **Game** preset mode.

---

## Reset Color

Resets your monitor's color settings to the factory settings.

---





## Display

Use **Display** to adjust the images.

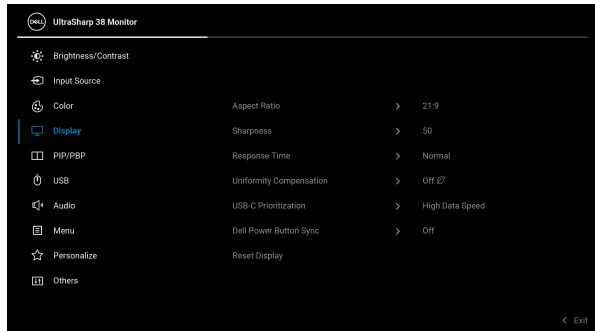

**Aspect Ratio** Adjusts the image ratio to **21:9**, **Auto Resize**, **4:3**, or **1:1**.

**Sharpness** This feature can make the image look sharper or softer. Move the joystick to adjust the sharpness level from '0' to '100'.

**Response Time** Allows you to set the response time to **Normal** or **Fast**.

**Uniformity Compensation** Select screen uniformity compensation settings. **Uniformity Compensation** adjusts different areas of the screen with respect to the center to achieve uniform brightness and color over the entire screen.





---

## USB-C Prioritization

Allows you to specify the priority to transfer the data with high resolution (**High Resolution**) or high speed (**High Data Speed**) when using the USB Type-C port/DisplayPort. If the current platform is DP 1.4 (HBR3), use **High Data Speed** to access full video performance with high data speed. If the current platform is DP 1.2 (HBR2) or below, select **High Resolution** for accessing full video performance with data and network speed drop.

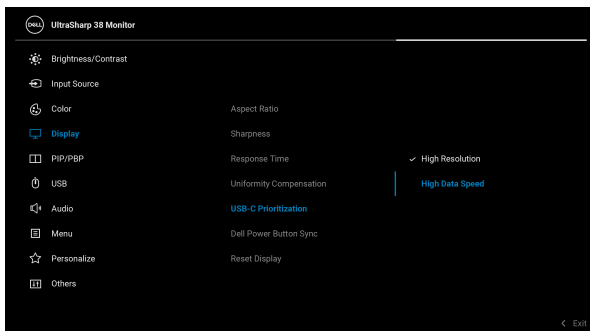

---

## Dell Power Button Sync

Allows you to control PC system power state from the monitor power button.

**NOTE:** When **Off** is selected, the Wake-on-Connect function remains active.

---

## Reset Display

Resets all display settings to the factory preset values.

---





## PIP/PBP

This function brings up a window displaying images from another input source. Press the joystick to confirm the selection.

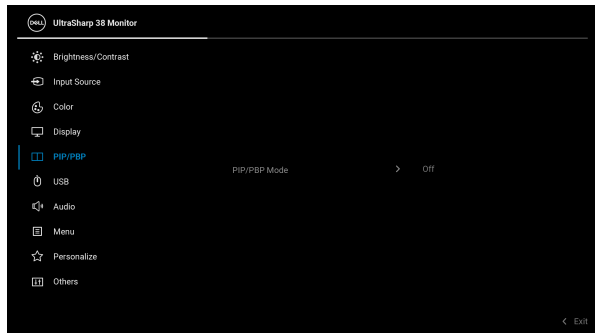

Main Window	Sub-Window			
	USB-C	DP	HDMI 1	HDMI 2
USB-C	—	✓	✓	✓
DP	✓	—	✓	✓
HDMI 1	✓	✓	—	✓
HDMI 2	✓	✓	✓	—

**NOTE:** The images under PBP mode will be displayed at the center of the split windows.



---

**PIP/PBP Mode** Allows you to choose a PBP or PIP mode from the preset list, which provides different sizes and positions of the sub-window. The options are shown in graphic format, giving a quick understanding of various layout settings. The default setting is **Off**.

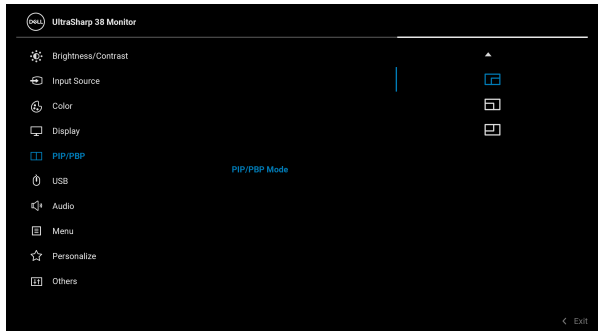
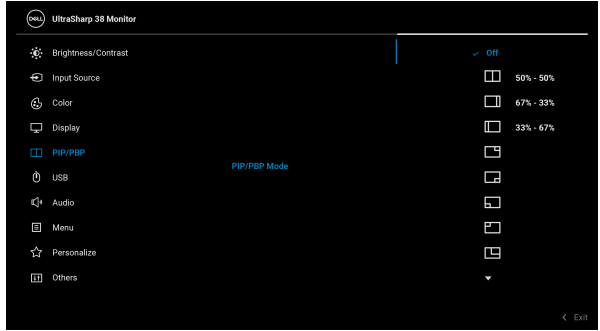

---

**PIP/PBP (Sub)** Select a video signal that may be connected to your monitor for the PIP/PBP sub-window. Press the joystick to confirm the selection.

**NOTE:** The feature is available only when the PIP/PBP mode is enabled.



---

**USB Switch** Select to switch between the USB upstream sources in PIP/PBP mode.

**NOTE:** The feature is available only when the PIP/PBP mode is enabled.

---

**Video Swap** Select to swap videos between the main window and sub-window in PIP/PBP mode. Press the joystick to confirm the selection.

**NOTE:** The feature is available only when the PIP/PBP mode is enabled.

---

**Audio** Allows you to set the audio source from the main window or the sub-window.

**NOTE:** The feature is available only when the PIP/PBP mode is enabled.

---

**Contrast (Sub)** Adjusts the contrast level of the picture in PIP/PBP mode. Move the joystick to adjust the contrast level from '0' to '100'.

**NOTE:** The feature is available only when the PIP/PBP mode is enabled.

---





## USB

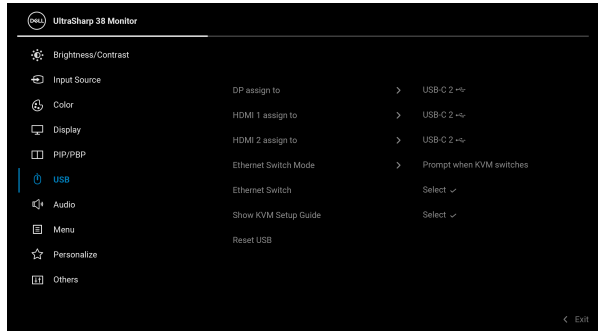

---

### DP assign to HDMI 1 assign to HDMI 2 assign to

Allows you to assign the USB upstream ports for the input signals (DP, HDMI 1, or HDMI 2), thus the monitor's USB downstream port (e.g. keyboard and mouse) can be used by the current input signals when you connect a computer to either one of the upstream ports. See also [Setting the KVM switch](#) for details.

When you use only one upstream port, the connected upstream port is active.

**NOTE:** To prevent data damage or loss, before unplugging the USB upstream port, make sure that NO USB storage devices are in use by the computer connected to the monitor's USB downstream port.

---

### Ethernet Switch Mode

Allows you to choose one from the three available modes:

- **Tie to KVM:** When KVM USB switches, Ethernet switches together.
- **Prompt when KVM switches:** When KVM USB switches, a message prompts user to decide whether to switch Ethernet together.
- **Switch Manually:** When KVM USB switches, Ethernet does not switch.

---

### Ethernet Switch

Manually switch Ethernet.



---

**Show KVM Setup Guide**

Displays the step-by-step KVM setup guide. Follow the steps if you want to connect multiple computers to the monitor and use one setup of keyboard and mouse.

---

**Reset USB**

Resets all USB settings to the factory preset values.

---

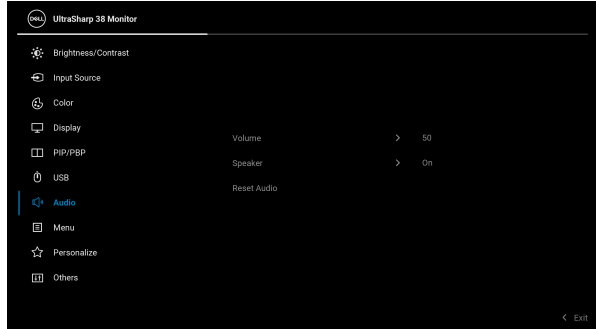
**Audio**

---

**Volume**

Allows you to set the volume level of speakers. Move the joystick to adjust the volume level from '0' to '100'.

---

**Speaker**

Allows you to turn on or off the speaker function.

---

**Reset Audio**

Restores the audio settings to the factory settings.

---





## Menu

Adjusts the settings of the OSD, such as, the languages of the OSD, the amount of time the menu remains on screen, and so on.

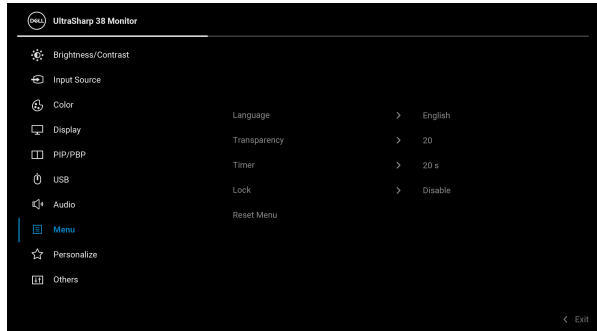

## Language

Sets the OSD display to one of the eight languages (English, Spanish, French, German, Brazilian Portuguese, Russian, Simplified Chinese, or Japanese).

## Transparency

Select to change the menu transparency by moving the joystick (min. 0/max. 100).

## Timer

Sets the length of time for the OSD to remain active after your last operation with the joystick.

Move the joystick to adjust the slider in 1 second increment, from 5 to 60 seconds.



---

## Lock

With the control buttons on the monitor locked, you can prevent people from accessing the controls.

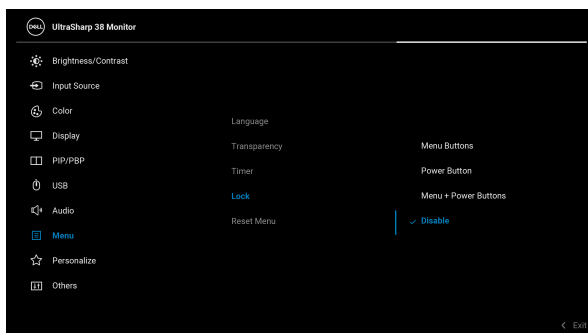

- **Menu Buttons:** All joystick functions are locked and not accessible by the user.
- **Power Button:** Only the Power button is locked and not accessible by the user.
- **Menu + Power Buttons:** Both the joystick & Power button are locked and not accessible by the user.

The default setting is **Disable**.

**Alternative Lock Method:** You can move and hold the joystick up or down or left or right for 4 seconds to set the lock options using the pop-up menu, and then press the joystick to confirm the configuration.

**NOTE:** To unlock, move and hold the joystick up or down or left or right for 4 seconds, and then press the joystick to confirm the changes and close the pop-up menu.

---

## Reset Menu

Resets all OSD settings to the factory preset values.

---







## Personalize

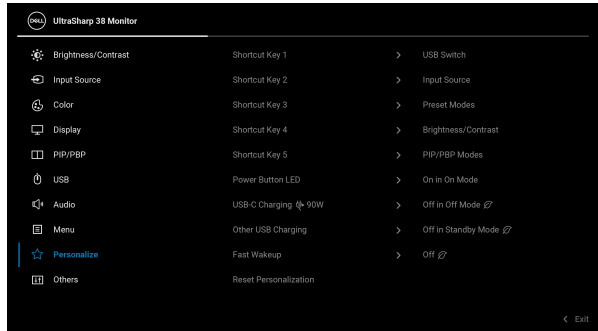

### Shortcut Key 1

### Shortcut Key 2

### Shortcut Key 3

### Shortcut Key 4

### Shortcut Key 5

Select a feature from **Preset Modes, Brightness/Contrast, Input Source, Aspect Ratio, PIP/PBP Mode, USB Switch, Ethernet Switch, Video Swap, Volume, or Display Info** and set it as a shortcut key.

### Power Button LED

Allows you to set the state of the power light to save energy.

### USB-C Charging 90W

Allows you to enable or disable the **USB-C Charging 90W** function during monitor off mode. When this function is enabled, you will be able to charge your notebook or mobile devices through the USB-C cable even when the monitor is powered Off.

**NOTE:** The function is not selectable and will be defaulted to **On in Off Mode** if Monitor is connected to Dell Latitude and Precision notebooks that support Dell Power Button Sync through USB-C. Under this configuration, the monitor USB-C charging function is always available during Off Mode.

### Other USB Charging

Allows you to enable or disable USB Type-A and USB Type-C (downstream ports) charging function when the monitor is in standby mode.

### Fast Wakeup

Speeds up recovery time from standby mode.



## Reset Personalization

Resets all settings under the **Personalize** menu to the factory preset values.



## Others

Adjusts the OSD settings, such as **DDC/CI**, **LCD Conditioning**, and so on.

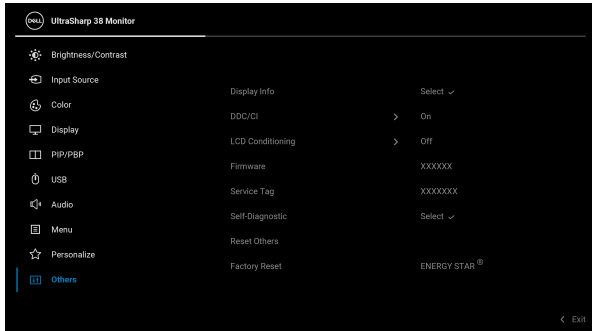

## Display Info

Displays the monitor's current settings.

## DDC/CI

**DDC/CI** (Display Data Channel/Command Interface) allows you to adjust the monitor settings using software on your computer. Enable this feature for the best user experience and optimum performance of your monitor. You can disable this feature by selecting **Off**.

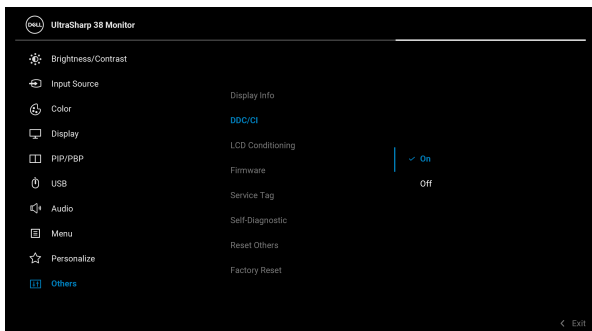

---

## LCD Conditioning

Helps reduce minor cases of image retention. Depending on the degree of image retention, the program may take some time to run. You can enable this feature by selecting **On**.

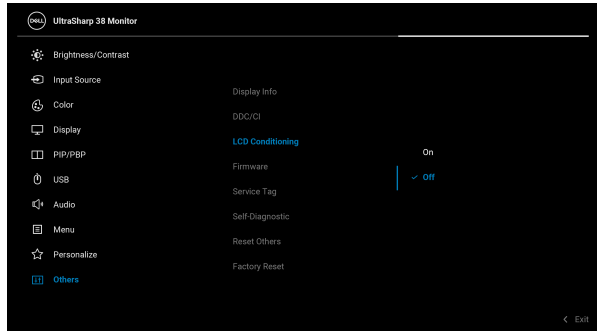

---

## Firmware

Displays the firmware version of your monitor.

---

## Service Tag

Displays the service tag of your monitor. This string is required when you look for phone support, check your warranty status, update drivers on Dell's website, etc.

---

## Self-Diagnostic

Press the joystick to initiate the self-diagnostic process.

1. When initiated, a gray screen appears.
2. Carefully inspect the screen for abnormalities.
3. Press the joystick. The color of the screen changes to red.
4. Inspect the display for any abnormalities.
5. Repeat steps 3 and 4 to inspect the display in green, blue, black, white and text screens.

The test is complete when the text screen appears. To exit, press the joystick again.

---

## Reset Others

Resets all settings under the **Others** menu to the factory preset values.

---



## Factory Reset

Restore all preset values to the factory default settings. These are also the settings for ENERGY STAR® tests.

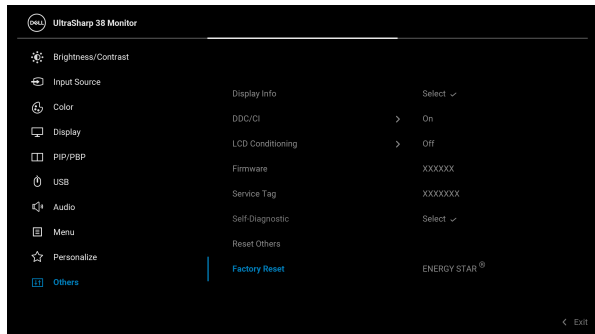

## OSD warning message

When the monitor does not support a particular resolution mode, you will see the following message:

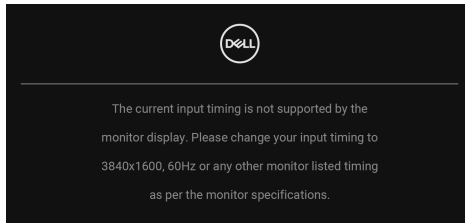

This means that the monitor cannot synchronize with the signal that it is receiving from the computer. See [Monitor specifications](#) for the Horizontal and Vertical frequency ranges addressable by this monitor. The recommended mode is **3840 x 1600**.

**NOTE:** The message may be slightly different according to the connected input signal.



When you select the **USB Switch** hotkey from the Menu Launcher, the following message appears if **PIP/PBP** function is disabled:

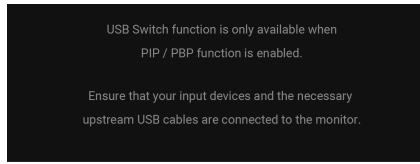

You will see the following message before the **DDC/CI** function is disabled:



When you adjust the **Brightness** level above the default level for the first time, the following message appears:

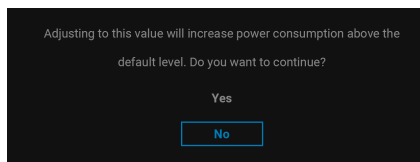

 **NOTE: If you select Yes, the message will not appear the next time you change the Brightness setting.**



When you change the default setting of power saving features for the first time, such as **Uniformity Compensation**, **USB-C Charging 65-90W**, **Other USB Charging**, or **Fast Wakeup**, the following message appears:

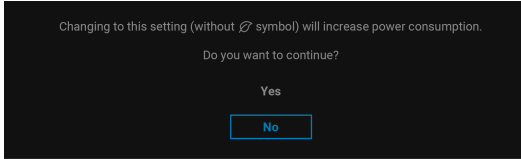

**NOTE:** If you select **Yes** for any of the features mentioned above, the message will not appear the next time you change the settings of these features. When you perform a factory reset, the message will appear again.

You will see the following message before the **Lock** function is activated:

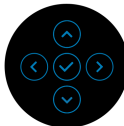
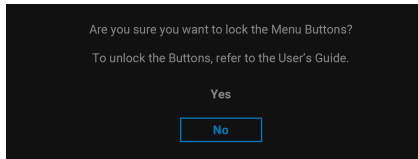

**NOTE:** The message may be slightly different according to the selected settings.



When you switch the USB Switch from PC 1 to PC 2, and **Ethernet Switch Mode** is set to **Prompt when KVM switches**, the following message appears:

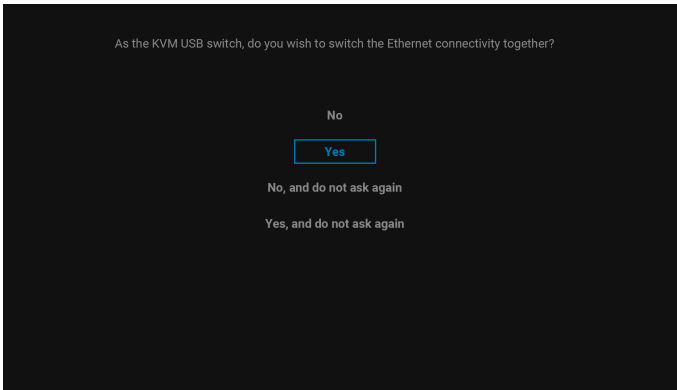

When the monitor is under DP/HDMI input and a USB Type-C cable is connected to a notebook that supports DP Alternate Mode, if **Auto Select for USB-C** is set to **Prompt for Multiple Inputs**, the following message appears:

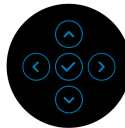
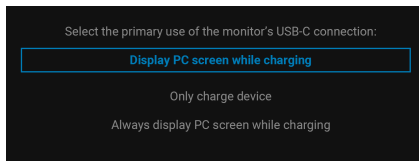

When the monitor goes into Standby mode, the following message appears:

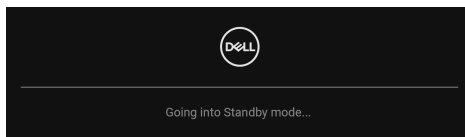

Activate the computer and wake up the monitor to gain access to the **OSD**.



The OSD functions only in the normal operation mode. If you press the joystick during the Standby mode, the following message will appear depending on the selected input:

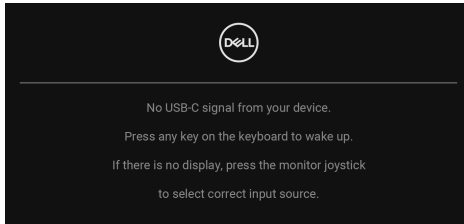

Activate the computer and the monitor to gain access to the **OSD**.

**NOTE: The message may be slightly different according to the connected input signal.**

If either USB Type-C, DisplayPort, or HDMI input is selected and the corresponding cable is not connected, the following message will appear:

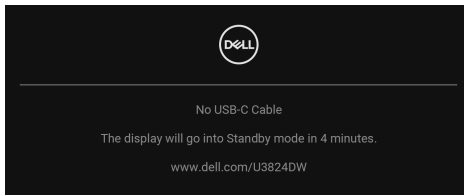

**NOTE: The message may be slightly different according to the selected input signal.**

When **Factory Reset** is selected, the following message appears:

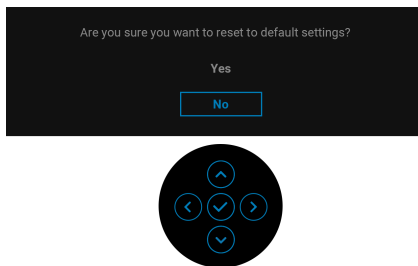



If you select **Yes** to reset to default settings, the following message appears:

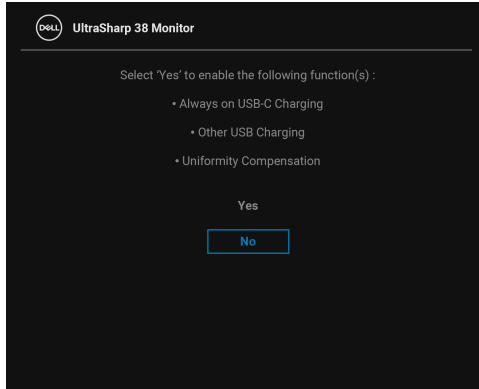

If you select **Yes** to reset to default settings, the following message appears:

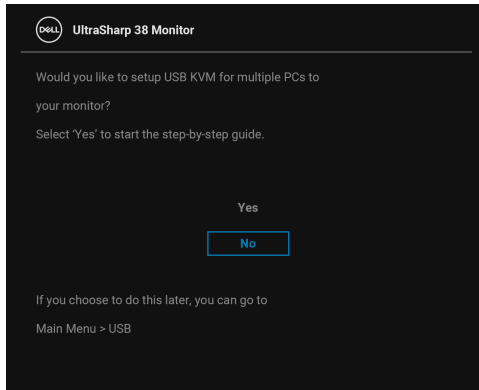

See [Troubleshooting](#) for more information.





## Locking the control buttons

You can lock the monitor control buttons to prevent access to the OSD menu and/or power button.

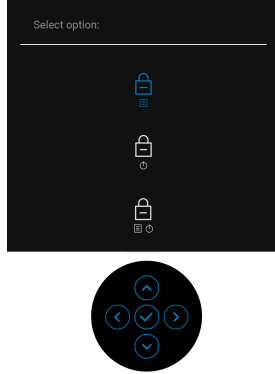
1. Move and hold the joystick up or down or left or right for about 4 seconds until a pop-up menu appears.



2. Move the joystick to select one of the following options:

-  : The OSD menu settings are locked and not accessible.
-  : The power button is locked.
-  : The OSD menu settings are not accessible and the power button is locked.

3. Press the joystick to confirm the configuration.

To unlock, move and hold the joystick up or down or left or right for about 4 seconds until a menu appears, and then select  to unlock and close the pop-up menu.

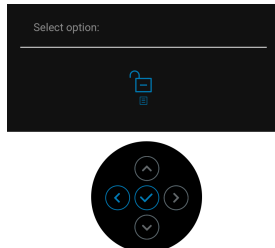

## Setting the KVM switch

The built-in KVM switch allows you to control up to 2 computers from a single set of keyboard and mouse connected to the monitor.

- a. When connecting **HDMI + USB-C (data only)** to computer 1 and **DP + USB-C (video and data)** to computer 2:

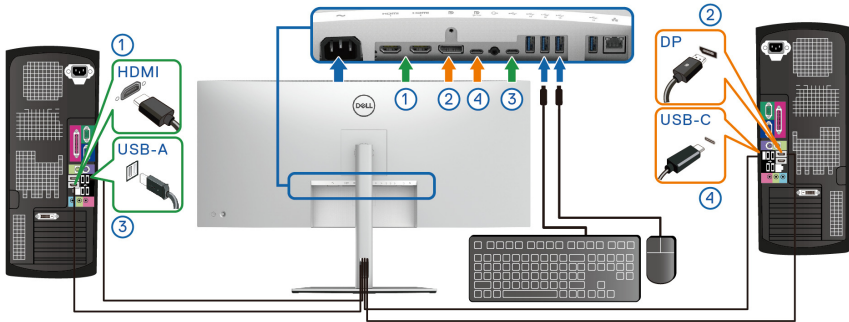

**NOTE:** The USB Type-C connection currently supports data transfer only.

Ensure that **USB** for **HDMI** is assigned to **USB-C2** and **DP** is assigned to **USB-C1**.

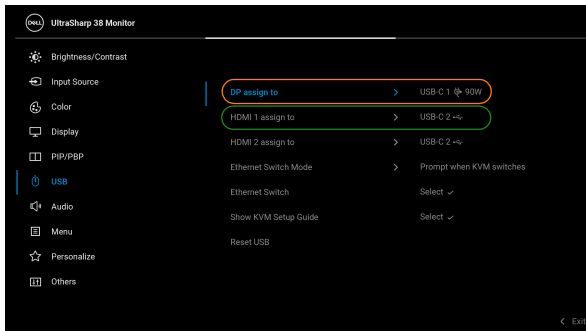

b. When connecting **HDMI + USB-C (data only)** to computer 1 and **USB-C (video and data)** to computer 2:

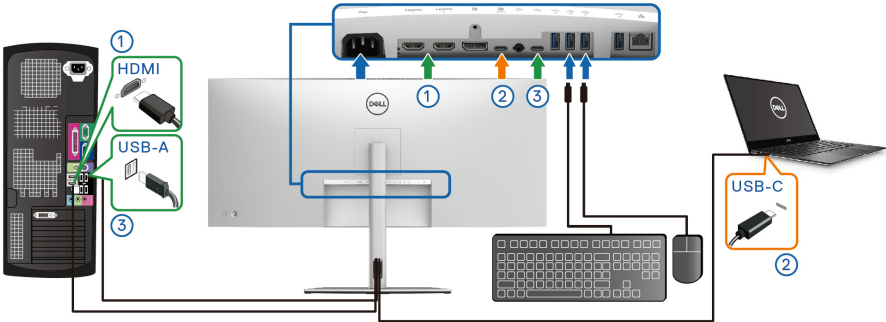

**NOTE:** The USB Type-C (video and data) connection currently supports video and data transfer.

Ensure that **USB for HDMI** is assigned to **USB-C2** .

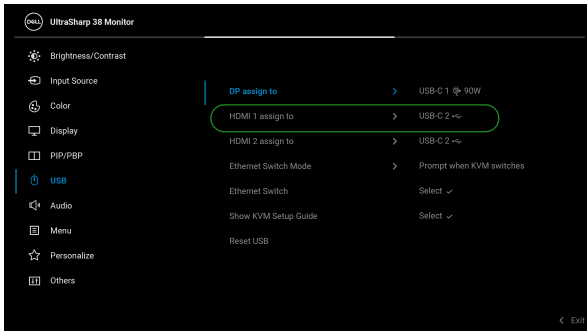

**NOTE:** As the USB Type-C (video and data) port supports the DisplayPort Alternate Mode, there is no need to set USB for USB-C.

**NOTE:** When connecting to different video input sources not shown above, follow the same method to make correct settings for USB to pair the ports.



## Setting the maximum resolution

 **NOTE: The steps may vary slightly depending on the version of Windows you have.**

To set the maximum resolution for the monitor:

In Windows 8.1:

1. For Windows 8.1, select the Desktop tile to switch to classic desktop.
2. Right-click on the desktop and click **Screen resolution**.
3. If you have more than one monitor connected, ensure that you select **U3824DW**.
4. Click the **Screen Resolution** dropdown list and select **3840 x 1600**.
5. Click **OK**.

In Windows 10 and Windows 11:

1. Right-click on the desktop and click **Display settings**.
2. If you have more than one monitor connected, ensure to select **U3824DW**.
3. Click the **Display Resolution** dropdown list and select **3840 x 1600**.
4. Click **Keep changes**.

If you do not see 3840 x 1600 as an option, you must update your graphics driver to the latest version. Depending on your computer, complete one of the following procedures:

If you have a Dell desktop or laptop:

- Go to [www.dell.com/support](http://www.dell.com/support), enter your service tag, and download the latest driver for your graphics card.

If you are using a non-Dell computer (laptop or desktop):

- Go to the support site for your non-Dell computer and download the latest graphic card drivers.
- Go to the graphics card's website and download the latest graphic card drivers.



## Using the tilt, swivel, vertical extension, and slant adjust

**NOTE:** The following instructions are applicable only for attaching the stand that was shipped with your monitor. If you are attaching a stand that you purchased from any other source, follow the setup instructions that were included with the stand.

### Tilt, swivel

With the stand attached to the monitor, you can tilt and swivel the monitor for the most comfortable viewing angle.

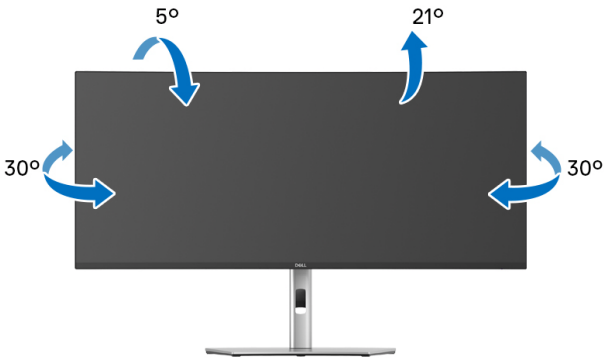

**NOTE:** The stand is not installed at the factory when shipped.

### Vertical extension

**NOTE:** The stand extends vertically up to 120 mm. The image below illustrates how to extend the stand vertically.

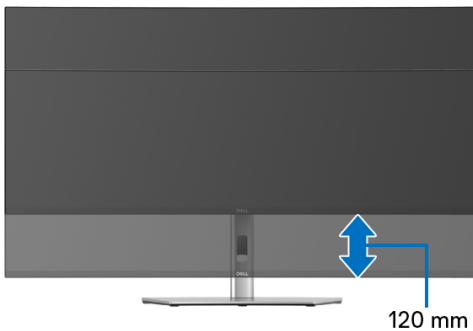

## Slant adjust

With the stand attached to the monitor, you can adjust the monitor to your desired angle with the slant adjust feature.



# Troubleshooting

 **WARNING:** Before you begin any of the procedures in this section, follow the [Safety instructions](#).

## Self-test

Your monitor provides a self-test feature that allows you to check whether your monitor is functioning properly. If your monitor and computer are properly connected but the monitor screen remains dark, run the monitor self-test by performing the following steps:

1. Turn Off both your computer and the monitor.
2. Unplug the video cable from the computer.
3. Turn On the monitor.

If the monitor cannot sense a video signal and is working correctly, the following message will appear:

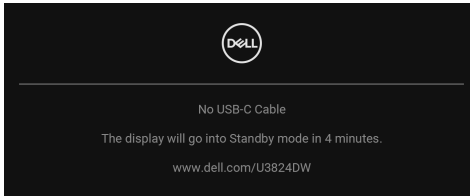

 **NOTE:** The message may be slightly different according to the connected input signal.

 **NOTE:** While in self-test mode, the power LED remains white.

4. This box also appears during normal system operation, if the video cable becomes disconnected or damaged.
5. Turn Off your monitor and reconnect the video cable; then turn On both your computer and the monitor.

If your monitor screen remains blank after you use the previous procedure, check your video controller and computer, because your monitor is functioning properly.





## Common problems

The following table contains general information about common monitor problems you might encounter and the possible solutions:

Common symptoms	What you experience	Possible solutions
No video/power LED off	No picture	<ul style="list-style-type: none"><li>• Ensure that the video cable connecting the monitor and the computer is properly connected and secure.</li><li>• Verify that the power outlet is functioning properly using any other electrical equipment.</li><li>• Ensure that the power button is pressed fully.</li><li>• Ensure that the correct input source is selected in the <a href="#">Input Source</a> menu.</li></ul>
No video/power LED on	No picture or no brightness	<ul style="list-style-type: none"><li>• Increase brightness and contrast controls using the OSD.</li><li>• Perform monitor self-test feature check.</li><li>• Check for bent or broken pins in the video cable connector.</li><li>• Run the built-in diagnostics.</li><li>• Ensure that the correct input source is selected in the <a href="#">Input Source</a> menu.</li></ul>
Poor focus	Picture is fuzzy, blurry, or ghosting	<ul style="list-style-type: none"><li>• Eliminate video extension cables.</li><li>• Reset the monitor to factory settings.</li><li>• Change the video resolution to the correct aspect ratio.</li></ul>
Shaky/jittery video	Wavy picture or fine movement	<ul style="list-style-type: none"><li>• Reset the monitor to factory settings.</li><li>• Check environmental factors.</li><li>• Relocate the monitor and test in another room.</li></ul>



Missing pixels	LCD screen has spots	<ul style="list-style-type: none"> <li>• Cycle power On-Off.</li> <li>• Pixel that is permanently Off is a natural defect that can occur in LCD technology.</li> <li>• For more information on Dell Monitor Quality and Pixel Policy, see Dell Support site at: <a href="http://www.dell.com/pixelguidelines">www.dell.com/pixelguidelines</a>.</li> </ul>
Stuck-on pixels	LCD screen has bright spots	<ul style="list-style-type: none"> <li>• Cycle power On-Off.</li> <li>• Pixel that is permanently off is a natural defect that can occur in LCD technology.</li> <li>• For more information on Dell Monitor Quality and Pixel Policy, see Dell Support site at: <a href="http://www.dell.com/pixelguidelines">www.dell.com/pixelguidelines</a>.</li> </ul>
Brightness problems	Picture too dim or too bright	<ul style="list-style-type: none"> <li>• Reset the monitor to factory settings.</li> <li>• Adjust brightness and contrast controls using the OSD.</li> </ul>
Geometric distortion	Screen not centered correctly	Reset the monitor to factory settings.
Horizontal/vertical lines	Screen has one or more lines	<ul style="list-style-type: none"> <li>• Reset the monitor to factory settings.</li> <li>• Perform monitor self-test feature check and determine if these lines are also in self-test mode.</li> <li>• Check for bent or broken pins in the video cable connector.</li> <li>• Run the built-in diagnostics.</li> </ul>



Synchronization problems	Screen is scrambled or appears torn	<ul style="list-style-type: none"> <li>• Reset the monitor to factory settings.</li> <li>• Perform monitor self-test feature check to determine if the scrambled screen appears in self-test mode.</li> <li>• Check for bent or broken pins in the video cable connector.</li> <li>• Restart the computer in the safe mode.</li> </ul>
Safety related issues	Visible signs of smoke or sparks	<ul style="list-style-type: none"> <li>• Do not perform any troubleshooting steps.</li> <li>• Contact Dell immediately.</li> </ul>
Intermittent problems	Monitor malfunctions on and off	<ul style="list-style-type: none"> <li>• Ensure that the video cable connecting the monitor to the computer is connected properly and is secure.</li> <li>• Reset the monitor to factory settings.</li> <li>• Perform monitor self-test feature check to determine if the intermittent problem occurs in self-test mode.</li> </ul>
Missing color	Picture missing color	<ul style="list-style-type: none"> <li>• Perform monitor self-test feature check.</li> <li>• Ensure that the video cable connecting the monitor to the computer is connected properly and is secure.</li> <li>• Check for bent or broken pins in the video cable connector.</li> </ul>



Wrong color	Picture color not good	<ul style="list-style-type: none"> <li>Change the settings of the <b>Preset Modes</b> in the <b>Color</b> menu OSD depending on the application.</li> <li>Adjust the <b>Gain/Offset/Hue/Saturation</b> values under <b>Custom Color</b> in <b>Color</b> menu OSD.</li> <li>Change the <b>Input Color Format</b> to <b>RGB</b> or <b>YCbCr/YPbPr</b> in the <b>Color</b> settings OSD.</li> <li>Run the built-in diagnostics.</li> </ul>
Image retention from a static image left on the monitor for a long period of time	Faint shadow from the static image displayed appears on the screen	<ul style="list-style-type: none"> <li>Set the screen to turn off after a few minutes of screen idle time. These can be adjusted in Windows Power Options or Mac Energy Saver setting.</li> <li>Alternatively, use a dynamically changing screensaver.</li> </ul>
Picture quality (Refresh rate of native resolution changes from 60 Hz to 30 Hz; or color depth drops to 18 bits)	Issues of incorrect refresh rate or missing colors	Set <b>USB-C Prioritization</b> to <b>High Resolution</b> .



## Product specific problems

Specific symptoms	What you experience	Possible solutions
Screen image is too small	Image is centered on screen, but does not fill entire viewing area	<ul style="list-style-type: none"> <li>• Check the <b>Aspect Ratio</b> setting in the <b>Display</b> menu OSD.</li> <li>• Reset the monitor to factory settings.</li> </ul>
Cannot adjust the monitor with the joystick	OSD does not appear on the screen	<ul style="list-style-type: none"> <li>• Turn Off the monitor, unplug the power cord, plug it back, and then turn On the monitor.</li> <li>• Check whether the OSD menu is locked. If yes, move and hold the joystick up/down/left/right for 4 seconds to unlock (see <a href="#">Lock</a> and <a href="#">Locking the control buttons</a>).</li> </ul>
No input signal when user controls are pressed	No picture, the LED light is white	<ul style="list-style-type: none"> <li>• Check the signal source. Ensure the computer is not in the power saving mode by moving the mouse or pressing any key on the keyboard.</li> <li>• Check whether the signal cable is plugged in properly. Re-plug the signal cable if necessary.</li> <li>• Reset the computer or video player.</li> </ul>
The picture does not fill the entire screen	The picture cannot fill the height or width of the screen	<ul style="list-style-type: none"> <li>• Due to different video formats (aspect ratio) of DVDs, the monitor may display in full screen.</li> <li>• Run the built-in diagnostics.</li> </ul>
No video at HDMI/DisplayPort/USB Type-C port	When connected to some dongle/docking device at the port, there is no video when unplugging/plugging the cable from the notebook	<ul style="list-style-type: none"> <li>• Unplug the HDMI/DisplayPort/USB Type-C cable from dongle/docking device, then plug the docking HDMI/DisplayPort/USB Type-C cable to the notebook.</li> </ul>



No network connection	Network dropped or intermittent	<ul style="list-style-type: none"> <li>• Check to ensure <b>USB-C Prioritization</b> is set to <b>High Data Speed</b>.</li> <li>• Do not turn Off the display during network connection.</li> </ul>
Not working with Dell external or embedded webcam	An error message appears while using the Windows Camera app	Download DPM (Dell Peripheral Manager) and use Dell's camera app instead.

## Universal Serial Bus (USB) specific problems

Specific symptoms	What you experience	Possible solutions
USB interface is not working	USB peripherals are not working	<ul style="list-style-type: none"> <li>• Check that your monitor is turned On.</li> <li>• Reconnect the upstream cable to your computer.</li> <li>• Reconnect the USB peripherals (downstream connector).</li> <li>• Switch Off and then turn On the monitor again.</li> <li>• Reboot the computer.</li> <li>• Some USB devices like external portable HDD require higher electric current; connect the device directly to the computer system.</li> </ul>
USB Type-C port does not supply power	USB peripherals can not be charged	<ul style="list-style-type: none"> <li>• Check that the connected device is compliant with the USB-C specification. The USB Type-C upstream port (video and data) with  icon supports USB 3.2 Gen2 and an output of 90 W.</li> <li>• Check that you use the USB Type-C cable shipped with your monitor.</li> </ul>



Super speed USB 10 Gbps (USB 3.2 Gen2) interface is slow	Super speed USB 10 Gbps (USB 3.2 Gen2) peripherals working slowly or not working at all	<ul style="list-style-type: none"> <li>• Check that your computer is super speed USB 10 Gbps (USB 3.2 Gen2)-compatible.</li> <li>• Some computers have USB 3.2, USB 2.0, and USB 1.1 ports. Ensure that the correct USB port is used.</li> <li>• Reconnect the upstream cable to your computer.</li> <li>• Reconnect the USB peripherals (downstream connector).</li> <li>• Reboot the computer.</li> </ul>
Wireless USB peripherals stop working when a USB 3.2 device is plugged in	Wireless USB peripherals responding slowly or only working as the distance between itself and its receiver decreases	<ul style="list-style-type: none"> <li>• Increase the distance between the USB 3.2 peripherals and the wireless USB receiver.</li> <li>• Position your wireless USB receiver as close as possible to the wireless USB peripherals.</li> <li>• Use a USB-extender cable to position the wireless USB receiver as far away as possible from the USB 3.2 port.</li> </ul>

## Speakers specific problems

Specific symptoms	What you experience	Possible solutions
No sound coming from the external speakers	Cannot hear any sound	<ul style="list-style-type: none"> <li>• Turn Off the monitor, unplug the monitor power cord, replug it, and then turn On the monitor.</li> <li>• Ensure the audio cable is connected correctly between the Audio Line Out port and the external speaker.</li> <li>• Disconnect/reconnect the audio cable from the Audio Line Out port and the external speaker.</li> <li>• Reset the monitor to factory settings.</li> </ul>



# Regulatory information

## FCC notices (U.S. only) and other regulatory information

For FCC notices and other regulatory information, see the regulatory compliance website located at [www.dell.com/regulatory\\_compliance](http://www.dell.com/regulatory_compliance).

## EU product database for energy label and product information sheet

U3824DW: <https://eprel.ec.europa.eu/qr/1361189>

# Contacting Dell

To contact Dell for sales, technical support, or customer service issues, see [www.dell.com/contactdell](http://www.dell.com/contactdell).

 **NOTE: Availability varies by country and product, and some services may not be available in your country.**

 **NOTE: If you do not have an active internet connection, you can find contact information on your purchase invoice, packing slip, bill, or Dell product catalog.**

