

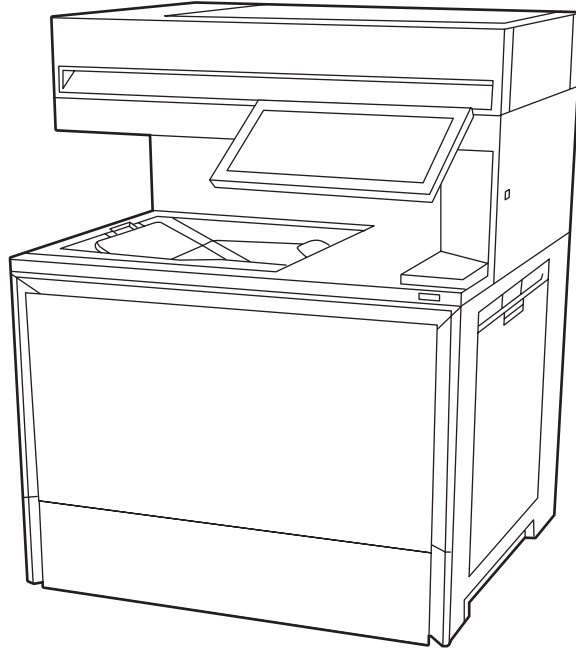

HP Color LaserJet Enterprise MFP 6800, 6801
HP Color LaserJet Enterprise Flow MFP 6800, 6801



6800, 6800dn, 6800zf, 6800zfs, 6800zfw+, 6801, 6801zfs, 6801zfw+

EN Installation Guide
FR Guide d'installation

ES Guía de instalación
PT Guia de instalação

ES Lea esto primero



www.hp.com/support/colorlj6800MFP
www.hp.com/support/colorlj6801MFP

1

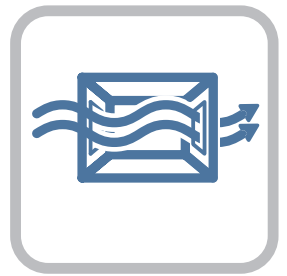
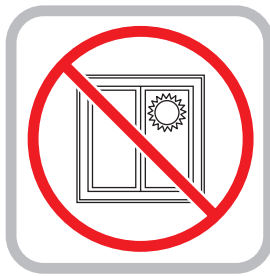
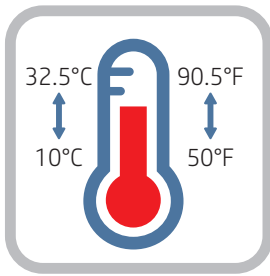

EN Select a sturdy, well-ventilated, dust-free area, away from direct sunlight to position the printer.

ES Busque una superficie sólida en un lugar bien ventilado, sin polvo y alejado de la luz solar directa para colocar la impresora.

FR Choisissez un support solide et un endroit propre, bien aéré et à l'abri du rayonnement direct du soleil pour placer votre imprimante.

PT Escolha um local firme, bem ventilado, sem poeira e longe da exposição direta à luz do sol para instalar a impressora.

2

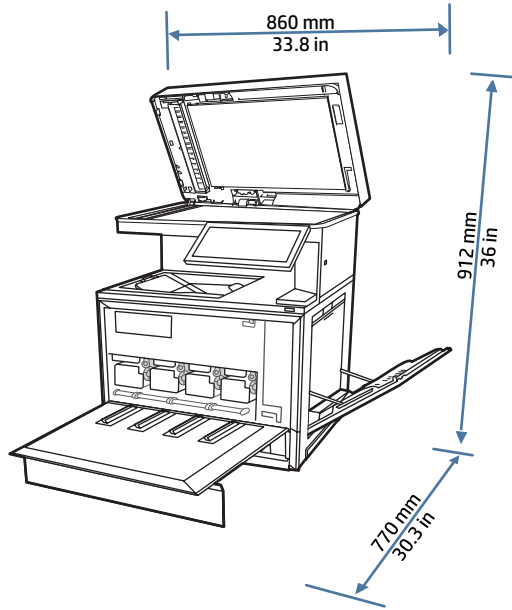
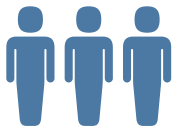
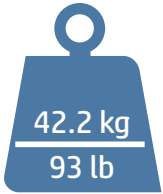
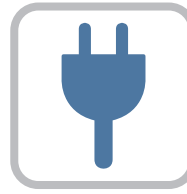
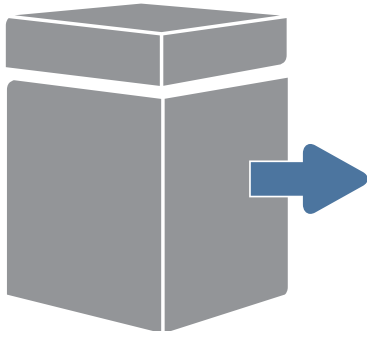

860 mm
33.8 in

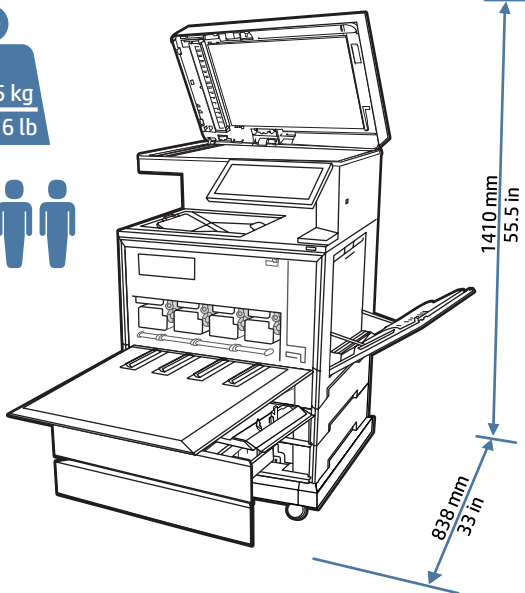

860 mm
33.8 in

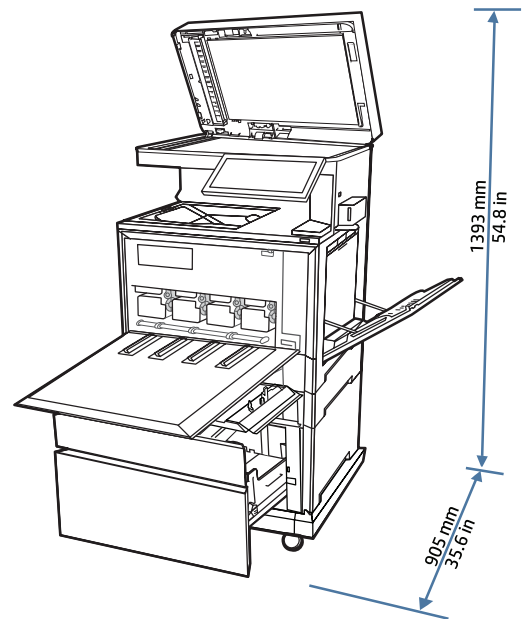

3

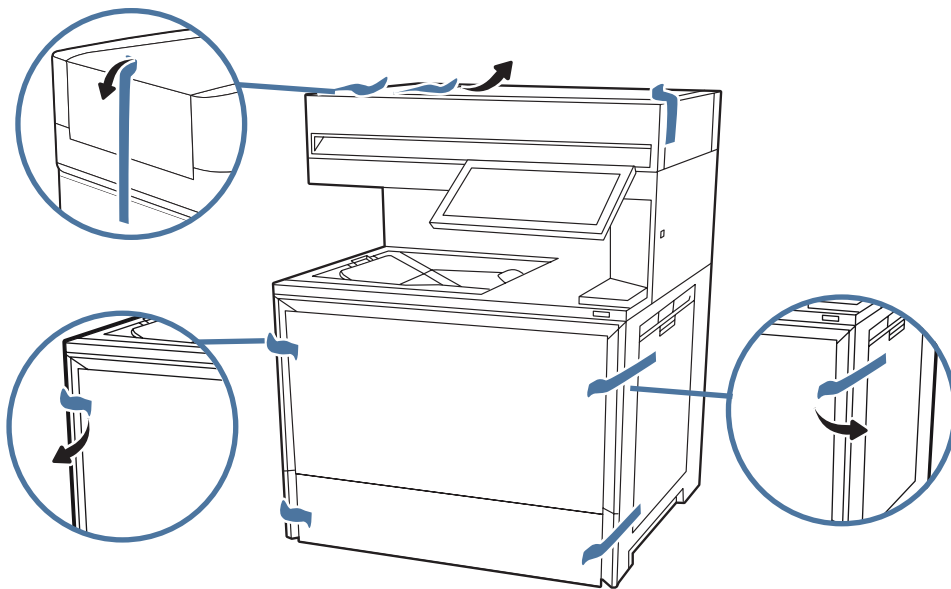

4

4.1

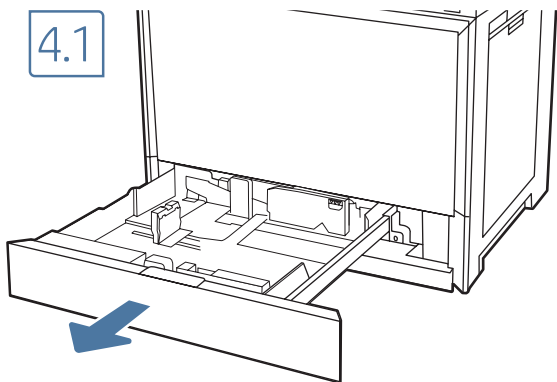

4.2

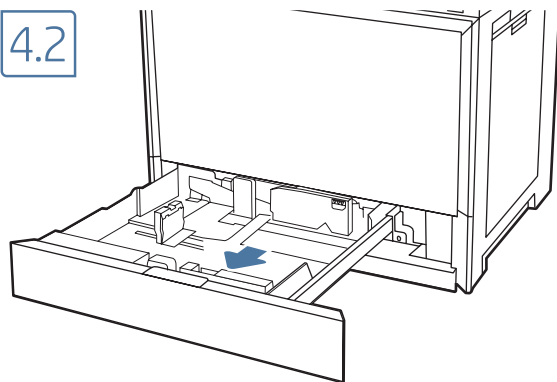

4.3

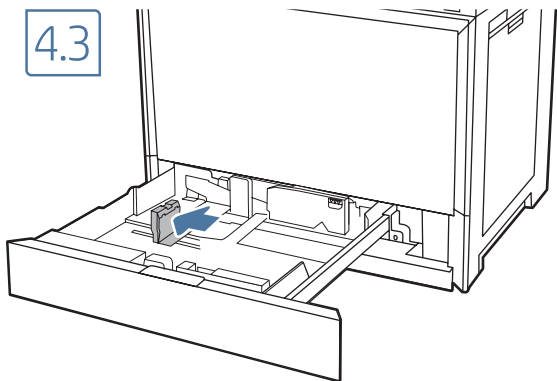

4.4

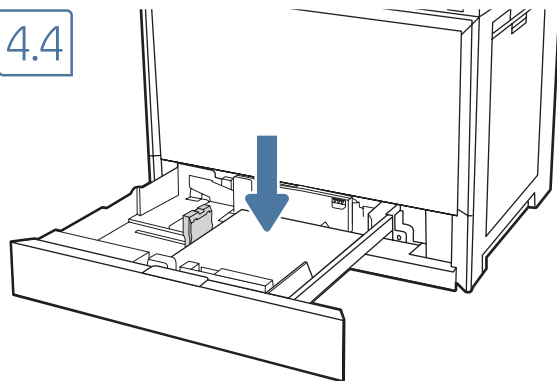

4.5

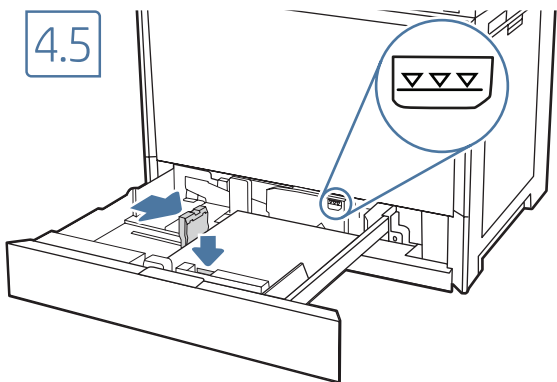

4.6

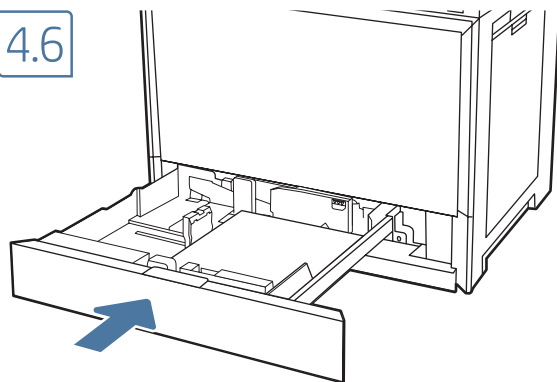

EN CAUTION: Do not extend more than one paper tray at a time. Do not use paper tray as a step. Keep hands out of paper trays when closing. All trays must be closed when moving the printer.

FR ATTENTION : N'utilisez pas plus d'un bac à papier à la fois. N'utilisez pas le bac à papier comme marchepied. Écartez vos mains des bacs à papier lors de la fermeture. Lorsque vous déplacez l'imprimante, tous les bacs doivent être fermés.

ES PRECAUCIÓN: no extienda más de una bandeja para papel cada vez. No utilice la bandeja para papel como apoyo para subirse encima. Mantenga las manos alejadas de las bandejas para papel cuando las cierre. Todas las bandejas deben estar cerradas para mover la impresora.

PT CUIDADO: Não estenda mais de uma bandeja de papel ao mesmo tempo. Não use a bandeja de papel como um degrau. Afaste suas mãos da bandeja de papel ao fechá-la. Todas as bandejas devem estar fechadas quando transportar a impressora.

5

EN If you ordered an additional 550-sheet tray, stand, panel kit, finisher, or storage stand, refer to the installation guide in the box. These need to be attached prior to connecting a network cable and connecting the power cable.

FR Si vous avez commandé un bac de 550 feuilles supplémentaire, un support, un module de finition, un kit de panneau, ou un support de stockage, consultez le guide d'installation qui se trouve dans la boîte. Ils doivent être fixés avant de connecter un câble réseau et de connecter le câble d'alimentation.

ES Si ha pedido una bandeja adicional para 550 hojas, un soporte, un kit de panel, un dispositivo de acabado o un soporte de almacenamiento, consulte la guía de instalación incluida en la caja. Es necesario colocarlos antes de conectar un cable de red y de conectar el cable de alimentación.

PT Se você pediu uma bandeja de papel adicional para 550 folhas, suporte, kit de painel ou suporte de armazenamento, consulte o guia de instalação na caixa. Eles precisam ser conectados antes de conectar um cabo de rede e conectar o cabo de alimentação.

6

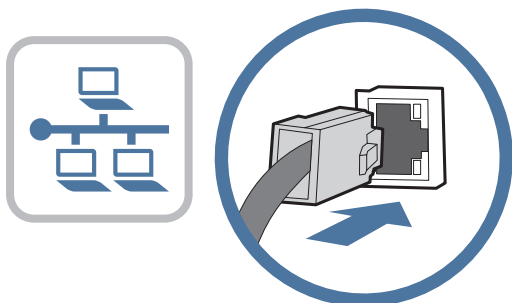

EN If you are connecting to a network, connect the network cable now. **CAUTION:** Do not connect the USB cable now. **NOTE:** The cables are not included with the printer.

FR Si vous vous connectez à un réseau, branchez le câble réseau maintenant. **ATTENTION :** Ne connectez pas le câble USB pour le moment. **REMARQUE :** Les câbles ne sont pas fournis avec l'imprimante.

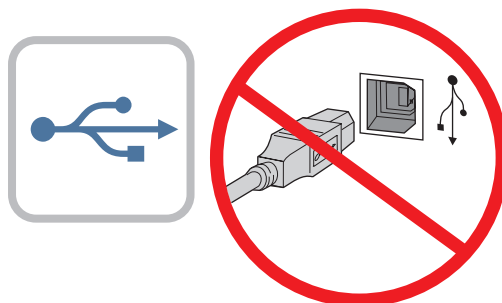

ES Si va a conectar la impresora a una red, conecte ahora el cable de red. **PRECAUCIÓN:** no conecte todavía el cable USB. **NOTA:** los cables no se incluyen con la impresora.

PT Se você estiver se conectando a uma rede, conecte o cabo de rede agora. **CUIDADO:** Não conecte o cabo USB agora. **NOTA:** Os cabos não são fornecidos com a impressora.

7

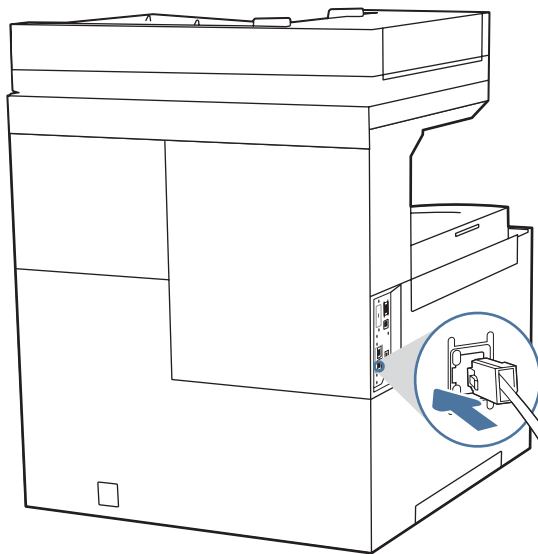

EN Connect the phone cord for fax. A country/region specific adapter for the RJ11 telephone cord may be required to connect to the telephone jack.
NOTE: The cables are not included with the printer.

FR Branchez le cordon téléphonique au télécopieur. Un adaptateur spécifique à votre pays/région pour le cordon de téléphone RJ11 peut être requis pour le branchement à la prise téléphonique.
REMARQUE : Les câbles ne sont pas fournis avec l'imprimante.

ES Conecte el cable telefónico para fax. Es posible que sea necesario usar un adaptador específico para el país/la región para conectar el cable telefónico RJ11 a la toma de teléfono.
NOTA: los cables no se incluyen con la impresora.

PT Conecte o cabo telefónico para fax. Um adaptador específico do país/região pode ser necessário para conectar o cabo telefónico RJ-11 à tomada telefónica.
NOTA: Os cabos não são fornecidos com a impressora.

8

8.1

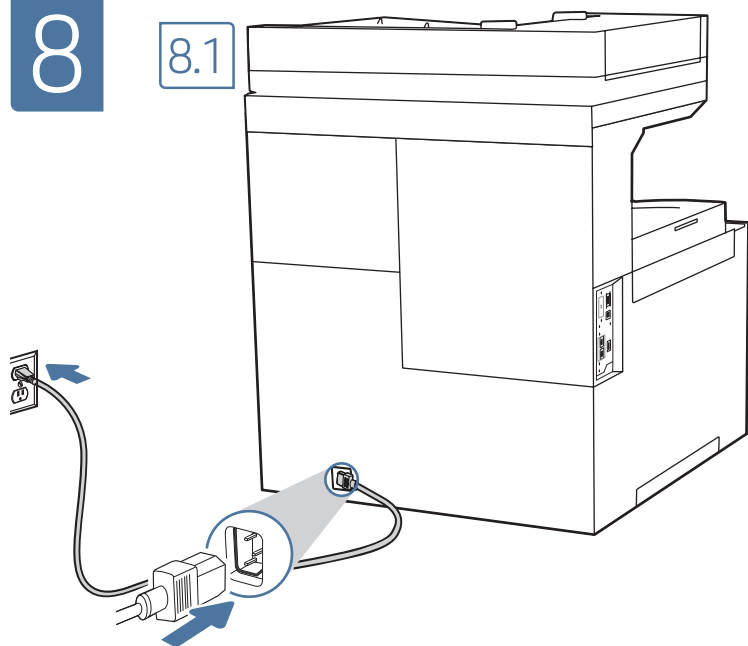

8.3

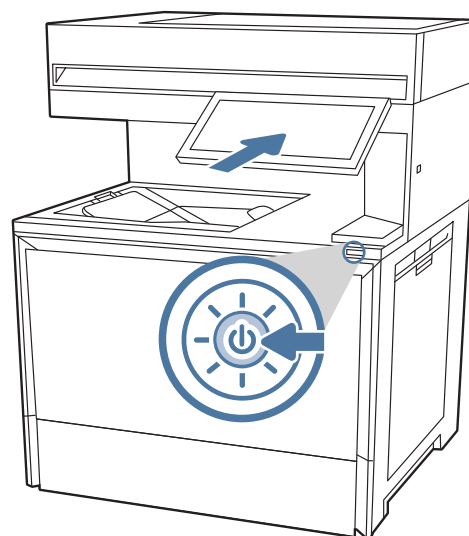

8.2

EN **8.1** Connect the power cable between the printer and a grounded AC outlet. **8.2** Turn on the printer, and then wait for it to initialize. **8.3** On the control panel, set the language, the date/time format, and the time zone.

NOTE: For advanced configuration of network-connected printers, enter the printer IP address in the address bar of a web browser after software installation is complete. To find the IP address, select the Information **i** button, and then select the Network **🌐** icon.



CAUTION: Make sure your power source is adequate for the printer voltage rating. The voltage rating is on the printer label. The printer uses either 100-127 Vac or 220-240 Vac and 50/60 Hz. To prevent damage to the printer, use only the power cable that is provided with the printer.

FR 8.1 Connectez le cordon d'alimentation entre l'imprimante et une prise secteur avec mise à la terre. 8.2 Allumez l'imprimante et attendez que le produit s'initialise. 8.3 Sur le panneau de commande, définissez la langue, le format de date/heure et le fuseau horaire.

REMARQUE : Pour effectuer la configuration avancée des imprimantes connectées en réseau, entrez l'adresse IP de l'imprimante dans la barre d'adresse d'un navigateur Web après avoir terminé l'installation du logiciel. Pour rechercher l'adresse IP, sélectionnez le bouton d'information,..... 



ATTENTION : Vérifiez que la source d'alimentation électrique est adéquate pour la tension nominale de l'imprimante. Cette tension nominale est indiquée sur l'étiquette de l'imprimante. L'imprimante utilise 100-127 V (ca) ou 220-240 V (ca) et 50/60 Hz. Afin d'éviter d'endommager l'imprimante, utilisez uniquement le cordon d'alimentation fourni avec l'imprimante.

ES 8.1 Conecte el cable de alimentación a la impresora y a una toma de CA con conexión a tierra. 8.2 Encienda la impresora y aguarde hasta que se inicie. 8.3 En el panel de control, establezca el idioma, el formato de fecha y hora y la zona horaria.

NOTA: para realizar una configuración avanzada de las impresoras que se conectan a la red, cuando haya finalizado la instalación del software, introduzca la dirección IP de la impresora en la barra de direcciones de un navegador web. Para encontrar la dirección IP, seleccione el botón de información , y, a continuación, seleccione el ícono de red .

PRECAUCIÓN: asegúrese de que la fuente de alimentación sea la adecuada para el voltaje de la impresora. La información sobre el voltaje se encuentra en la etiqueta de la impresora. La impresora utiliza 100-127 V CA o 220-240 V CA y 50/60 Hz. Para evitar ocasionar daños a la impresora, utilice solo el cable de alimentación que se proporciona con esta.

PT 8.1 Conecte o cabo de alimentação entre a impressora e uma tomada CA aterrada. 8.2 Ligue a impressora e espere sua inicialização. 8.3 No painel de controle, defina o idioma, o formato de data/hora e o fuso horário.

NOTA: Para configuração avançada de impressoras conectadas em rede, digite o endereço IP da impressora na barra de endereço de um navegador da Web após concluir a instalação do software. Para encontrar o endereço IP, selecione o botão Informações , e, depois, o ícone de rede .

CUIDADO: Verifique se a fonte de alimentação é adequada para a classificação de tensão da impressora. A classificação de tensão está na etiqueta da impressora. A impressora utiliza 100-127 Vca ou 220-240 Vca e 50/60 Hz. Para evitar danos à impressora, utilize somente o cabo de alimentação fornecido com a impressora.

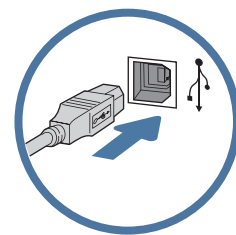
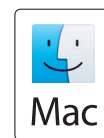
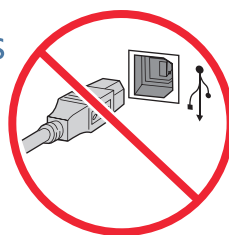
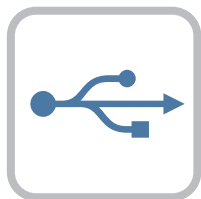

EN The high-speed USB port is disabled by default and must be enabled from the printer control panel. Open the **Settings** menu, and then select **General > Enable Device USB > Enabled**.

Windows: Do not connect the USB cable until prompted during the software installation in the next step. If the network cable was connected in step 6, proceed to step 10.

Mac: Connect the USB cable now.

NOTE: The cables are not included with the printer.

ES El puerto USB de alta velocidad se encuentra deshabilitado de forma predeterminada y se debe habilitar desde el panel de control de la impresora. Abra el menú **Configuraciones** y, a continuación, seleccione **General > Activar USB del dispositivo > Activado**.

Windows: no conecte el cable USB hasta que se le indique durante la instalación del software en el siguiente paso. Si se ha conectado el cable de red en el paso 6, vaya al paso 10.

Mac: conecte ahora el cable USB.

NOTA: los cables no se incluyen con la impresora.

FR Le port USB haute vitesse est désactivé par défaut et doit être activé du panneau de commande de l'imprimante. Ouvrez le menu **Paramètres**, puis sélectionnez **Généraux > Activer l'USB de l'appareil > Activé**.

Windows : Ne branchez pas le câble USB tant que vous n'y êtes pas invité durant l'installation du logiciel à l'étape suivante. Si vous avez connecté le câble réseau à l'étape 6, passez à l'étape 10.

Mac : Branchez le câble USB maintenant.

REMARQUE : Les câbles ne sont pas fournis avec l'imprimante.

PT A porta USB de alta velocidade está desabilitada por padrão e deve ser habilitada no painel de controle da impressora. Abra o menu **Configurações**, depois selecione **Geral > Habilitar Dispositivo USB > Habilitado**.

Windows: Não conecte o cabo USB até que seja solicitado a fazer isso durante a instalação do software na próxima etapa. Se o cabo de rede tiver sido conectado na etapa 6, prossiga para a etapa 10.

Mac: Conecte o cabo USB agora.

NOTA: Os cabos não são fornecidos com a impressora.

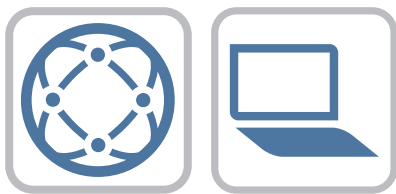

EN Locate or download the software installation files.

Method 1: Download HP Easy Start (Windows and macOS - clients)

1. Go to 123.hp.com and enter the printer name and model number, then click **Next**.
2. Follow the onscreen instructions to download and launch HP Smart.
3. Follow the onscreen instructions to select and run the printer software installation.

Method 2: Download from Product Support website (Windows clients and servers)

1. Go to www.hp.com/support/colorlj6800MFP, www.hp.com/support/colorlj6801MFP.
2. Select **Software and Drivers**.
3. Download the software for your printer model and operating system.

NOTE: Windows - **Driver - Product Installation Software** for clients, **Basic Drivers V3 and V4** for clients and servers.

4. Launch the installation file by clicking the .exe or .zip file as necessary.

Method 3: IT managed setup (Windows only - clients and servers)

Visit hp.com/go/smartupd to download and install the HP Smart Universal Print Driver.

ES Ubique o descargue los archivos de instalación del software.

Método 1: Descarga de HP Easy Start (clientes de Windows y macOS)

1. Acceda a 123.hp.com, introduzca el nombre y el número de modelo de la impresora y, a continuación, haga clic en **Siguiente**.
2. Siga las instrucciones en pantalla para descargar y ejecutar HP Smart.
3. Siga las instrucciones en pantalla para seleccionar y ejecutar la instalación del software de la impresora.

Método 2: Descarga desde el sitio web de asistencia del producto (clientes y servidores de Windows)

1. Acceda a www.hp.com/support/colorlj6800MFP, www.hp.com/support/colorlj6801MFP.
2. Seleccione **Software y controladores**.
3. Descargue el software para su modelo de impresora y sistema operativo.

NOTA: Windows - **Controlador - Software de instalación del producto** para clientes, **Controladores básicos V3 y V4** para clientes y servidores.

4. Haga clic en el archivo .exe o .zip según sea necesario para iniciar el archivo de instalación.

Método 3: Configuración administrada por TI (únicamente clientes y servidores de Windows)

Visite hp.com/go/smartupd para descargar e instalar HP Smart Universal Print Driver.

FR Localisez ou téléchargez les fichiers d'installation du logiciel.

Méthode 1 : Téléchargement de HP Easy Start (clients Windows et macOS)

1. Allez sur 123.hp.com et entrez le nom et le numéro de modèle de l'imprimante, puis cliquez sur **Suivant**.
2. Suivez les instructions à l'écran pour télécharger et lancer HP Easy Start.
3. Suivez les instructions à l'écran pour exécuter l'installation du logiciel d'impression.

Méthode 2 : Téléchargement du site Web d'assistance du produit (clients et serveurs Windows)

1. Accédez à www.hp.com/support/colorlj6800MFP, www.hp.com/support/colorlj6801MFP.
2. Sélectionnez **Pilotes et logiciels**.
3. Téléchargez le logiciel adapté à votre modèle d'imprimante et à votre système d'exploitation.

REMARQUE : Windows - **Pilote - logiciel d'installation de produits** pour les clients, **Pilotes de base V3 et V4** pour les clients et les serveurs.

4. Lancez le fichier d'installation en cliquant sur le fichier .exe ou .zip le cas échéant.

Méthode 3 : Configuration gérée par l'informatique (Windows uniquement - clients et serveurs)

Visitez la page hp.com/go/upd pour télécharger et installer le HP Universal Print Driver (Pilote d'impression universel HP).

PT Localize ou baixe os arquivos de instalação do software.

Método 1: Faça download do HP Easy Start (clientes Windows - macOS)

1. Acesse 123.hp.com e insira o nome da impressora e número do modelo, depois clique em **Próximo**.
2. Siga as instruções na tela para fazer download e iniciar o HP Smart.
3. Siga as instruções da tela para selecionar e executar a instalação do software da impressora.

Método 2: Faça download no site de Suporte do Produto (clientes e servidores do Windows)

1. Acesse www.hp.com/support/colorlj6800MFP, www.hp.com/support/colorlj6801MFP.
2. Selecione **Software e Drivers**.
3. Faça o download do software para seu modelo de impressora e sistema operacional.

NOTA: Windows - **Driver - Software de instalação do produto** para clientes, **Drivers básicos V3 e V4** para clientes e servidores.

4. Inicie o arquivo de instalação clicando no arquivo .exe ou .zip, como necessário.

Método 3: Configuração gerenciada de TI (Apenas Windows - clientes e servidores)

Acesse hp.com/go/upd para fazer download do HP Smart Universal Print Driver e instalá-lo.

11

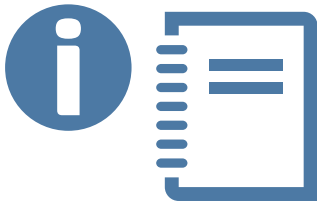

EN For more information on firmware updates and advanced configuration using the Embedded Web Server, see the User Guide or go to www.hp.com/support/colorlj6800MFP, www.hp.com/support/colorlj6801MFP.
Select the Help  button on the printer control panel to access Help topics.

FR Pour plus d'informations sur les mises à jour du micrologiciel et la configuration avancée à l'aide de l'Embedded Web Server, consultez le guide de l'utilisateur ou rendez-vous sur le site suivant www.hp.com/support/colorlj6800MFP, www.hp.com/support/colorlj6801MFP.
Sélectionnez le bouton d'aide  sur le panneau de commandes de l'imprimante pour accéder aux rubriques d'aide.

ES Para obtener más información sobre las actualizaciones de firmware y la configuración avanzada mediante el Servidor web incorporado, consulte la Guía del usuario o acceda a www.hp.com/support/colorlj6800MFP, www.hp.com/support/colorlj6801MFP.
Toque el botón de Ayuda  en el panel de control de la impresora para acceder a los temas de ayuda.

PT Para mais informações sobre atualizações de firmware e configuração avançada usando o Servidor da Web Integrado, vide o Guia do Usuário ou acesse www.hp.com/support/colorlj6800MFP, www.hp.com/support/colorlj6801MFP.
Selecione o botão Ajuda  no painel de controle da impressora para acessar os tópicos da Ajuda.

© Copyright 2022 HP Development Company, L.P.

Reproduction, adaptation or translation without prior written permission is prohibited, except as allowed under the copyright laws.

The information contained herein is subject to change without notice.

The only warranties for HP products and services are set forth in the express warranty statements accompanying such products and services. Nothing herein should be construed as constituting an additional warranty. HP shall not be liable for technical or editorial errors or omissions contained herein.

Trademark Credits

Microsoft, Windows, and Windows Server are trademarks of the Microsoft Group of companies.

macOS is a trademark of Apple Inc., registered in the U.S. and other countries.

AirPrint and the AirPrint logo are trademarks of Apple Inc.



La reproduction, l'adaptation ou la traduction de ce document sans l'autorisation écrite préalable de HP est interdite, sauf dans des conditions conformes aux lois relatives au copyright.

Les informations contenues dans ce document peuvent être modifiées sans préavis.

Les seules garanties pour les produits et services HP sont décrites dans les déclarations de garantie expresse qui accompagnent ces produits et services. Les informations contenues dans ce document ne constituent en aucun cas une garantie supplémentaire. HP n'est pas responsable des erreurs d'ordre technique ou éditorial ou des omissions contenues dans ce document.

Crédits concernant les marques

Microsoft, Windows et Windows Server sont des marques commerciales du groupe de sociétés Microsoft.

macOS est une marque commerciale d'Apple Inc. aux États-Unis et dans d'autres pays/régions.

Le nom et le logo AirPrint sont des marques de commerce d'Apple Inc.



6QN35-90053

